

WE REALLY CARE ABOUT YOU - PLEASE BUCKLE UP

Lexus has made a special effort to encourage use of seat belts.

Lexus belts are:

- **Comfortable**
- **Easy to use**
- **Convenient**

We encourage you to use your belts every time you drive.

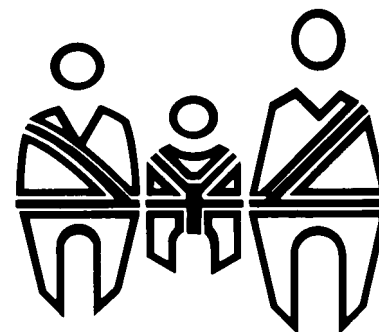

2003 GS430/300 from May '03 Prod. (OM30601U)

GS4/300 (U)

GAS STATION INFORMATION

- **Fuel selection:**
Select premium unleaded gasoline with an Octane Rating of 91 (Research Octane Number 96) or higher for optimum engine performance. However, if such premium type cannot be obtained, you may temporarily use unleaded gasoline with an Octane Rating as low as 87 (Research Octane Number 91).
- **Fuel tank capacity:**
75 L (19.8 gal., 16.5 Imp.gal.)
- **Engine oil:**
"Toyota Genuine Motor Oil" or equivalent

Oil grade: API grade SL "Energy-Conserving" or ILSAC multigrade engine oil.

Recommend oil viscosity – SAE 5W-30 if normal temperatures are below 38°C (100°F)

Oil capacity: L (qt., Imp.qt.)

Drain and refill	GS430	GS300
with filter	5.2 (5.5, 4.6)	5.4 (5.7, 4.8)
without filter	4.9 (5.2, 4.3)	5.1 (5.4, 4.5)

See page 260 for detailed information.
- **Engine coolant:**
Capacity: GS430: 9.0 L (9.5 qt., 7.9 Imp.qt.)
GS300: 7.7 L (8.1 qt., 6.8 Imp.qt.)

Coolant type – "Toyota Genuine Long Life Coolant" or equivalent

With ethylene-glycol type coolant for a proper corrosion protection of aluminum components

For checking the engine coolant, see page 264.

Do not use alcohol type antifreeze or plain water alone.

- **Automatic transmission:**
Fluid type – "Toyota Genuine ATF Type T-IV"

See page 270 or 274 for detailed information.

- **Tire information:**
See page 282 through 289 for detailed information.

- **Tire pressure:**
Tire size: GS430 – 225/55R16 94V or 235/45ZR17
GS300 – P215/60R16 94V or 225/55R16 94V

Tire pressure: cold tires
kPa (kgf/cm² or bar, psi)

Tire size	Front	Rear
P215/60R16 94V	210 (2.1, 30)	210 (2.1, 30)
225/55R16 94V	220 (2.2, 32)	220 (2.2, 32)
235/45ZR17	230 (2.3, 33)	230 (2.3, 33)

For sustained high speeds above 160 km/h (100 mph), in countries where such speeds are permitted by law, add the tire pressure given below to the front tires and rear tires, but never exceed the maximum cold tire pressure molded on the tire sidewall.

P215/60R16 94V	90kPa (0.9 kgf/cm ² or bar, 13 psi)
225/55R16 94V	80kPa (0.8 kgf/cm ² or bar, 12 psi)
235/45ZR17	70kPa (0.7 kgf/cm ² or bar, 10 psi)

You should know as much about the quality and importance of proper maintenance of your new vehicle as the people who built it.

The Lexus authorized Repair Manual tells you how to maintain your vehicle and enables you to correctly perform your own maintenance.



The best way to keep your new vehicle in top running order is to maintain it properly from the moment you drive it off the showroom floor.

The Lexus authorized Repair Manual is packed with literally everything you need to know to perform your own maintenance in virtually every area of your new vehicle.

Maintenance procedures for the engine, chassis, body, electrical system, and more, are clearly explained and illustrated.

Periodic maintenance and tune-up

Periodic maintenance and tune-up helps to prevent small problems from growing into larger ones later on. The repair manual outlines exactly what maintenance is required and clearly explains how to do the work yourself step-by-step.

Areas covered include such things as spark plug replacement, valve clearance adjustment and engine oil and filter replacement.

**Where to obtain the
Repair Manual**

The repair manual for GS430, GS300, written in English, may be purchased as applicable from any Lexus dealer.

Pub. Name: 2003 GS430, GS300 Repair Manual

Pub. No.: Vol.1 974U1

Vol.2 974U2

FOREWORD

Congratulations on your selection of this Lexus. In Lexus vehicles we have invested all our engineering and design resources; all the know-how we have gained in over 60 years of making automobiles; the highest motivation of our most talented employees; and our tradition of incessant striving toward ever greater quality.

This Owner's Manual explains the features of your new Lexus. Please read it and follow the instructions carefully so that you can enjoy many years of safe motoring.

When it comes to service, remember that your Lexus dealer knows your vehicle best and is interested in your complete satisfaction. Your Lexus dealer will provide quality maintenance and any other assistance you may require.

If there is not a Lexus dealer near you, or you need emergency assistance for any reason, please call the following number:

U.S. OWNERS

- When traveling in the U.S. mainland or Canada:
Lexus Roadside Assistance 1-800-25-LEXUS (Toll-Free)
(1-800-255-3987)
- HAWAII:
Lexus Customer Service Assistance 1-800-25-LEXUS (Toll-Free)
(1-800-255-3987)

CANADIAN OWNERS

- When traveling in Canada or the U.S. mainland:
Lexus Roadside Assistance/Customer Service 1-800-26-LEXUS (Toll-Free)
(1-800-265-3987)

Please leave this Owner's Manual in this vehicle at the time of resale. The next owner will need this information also.

All information and specifications in this manual are current at the time of printing. However, because of the Lexus policy of continual product improvement, we reserve the right to make changes at any time without notice.

Please note that this manual applies to all models and explains all equipment, including options. Therefore, you may find some explanations for equipment not installed on your vehicle.

TOYOTA MOTOR CORPORATION

INTRODUCTION

New vehicle warranty

Your new vehicle is covered by the following Lexus limited warranties:

- New vehicle warranty
- Emission control systems warranty
- Others

For further information, please refer to the "Owner's Guide", "Owner's Manual Supplement" or "Warranty Booklet".

Your responsibility for maintenance

It is the owner's responsibility to make sure the specified maintenance is performed. Section 5 of this Owner's Manual gives details of these maintenance requirements. Included in Section 6 is general maintenance. For scheduled maintenance information, please refer to the "Owner's Manual Supplement / Scheduled Maintenance".

Accessories, spare parts and modification of your Lexus

A wide variety of non-genuine spare parts and accessories for Lexus vehicles are currently available in the market. You should know that Toyota does not warrant these products and is not responsible for their performance, repair, or replacement, or for any damage they may cause to, or adverse effect they may have on, your Lexus vehicle.

This vehicle should not be modified with non-genuine Lexus products. Modification with non-genuine Lexus products could affect its performance, safety or durability, and may even violate governmental regulations. In addition, damage or performance problems resulting from the modification may not be covered under warranty.

Spark ignition system of your Lexus

The spark ignition system in your Lexus meets all requirements of the Canadian Interference-Causing Equipment Standard.

Installation of a mobile two-way radio system

As the installation of a mobile two-way radio system in your vehicle could affect electronic systems such as the multiport fuel injection system/sequential multiport fuel injection system, cruise control system, anti-lock brake system, SRS airbag system and seat belt pretensioner system, be sure to check with your Lexus dealer for precautionary measures or special instructions regarding installation.

Scrapping of your Lexus

The SRS airbag and seat belt pretensioner devices in your Lexus contain explosive chemicals. If the vehicle is scrapped with the airbags and seat belt pretensioners left as they are, this may cause an accident such as fire. Be sure to have the systems of the SRS airbag and seat belt pretensioner removed and disposed of by a qualified service shop or by your Lexus dealer before you scrap your vehicle.

HOW TO USE THIS MANUAL

The contents of this manual are explained briefly on this page to help you make the best use of the manual. Please read this page and the rest of the Owner's Manual carefully to make sure you fully understand the operation of your vehicle.

This will help you enjoy safe and comfortable driving.

TABLE OF CONTENTS

The table of contents and the pictorial index provide easy reference to the appropriate pages.

BASIC OPERATION – QUICK REFERENCE

Operation of basic equipment is briefly explained in an easily understandable way for quick reference.

SECTION 1 – INSTRUMENTS AND CONTROLS

The vehicle's equipment is divided into the 7 groups listed below. Use of the equipment is explained, including any points you should pay particular attention to.

1. Keys and doors
2. Switches
3. Gauges, meters and service reminder indicators
4. Interior equipment
5. Exterior equipment
6. Comfort adjustment
7. Theft deterrent

SECTION 2 – AIR CONDITIONING AND AUDIO

The features of the vehicle's air conditioning and audio are explained in detail. Be sure to read this section so that you can make full use of them.

SECTION 3 – STARTING AND DRIVING

Starting the engine, driving, stopping, operation of features affecting vehicle handling, hints on vehicle safety and safe driving techniques are all explained. Please read everything in this section, and remember – drive safely!

SECTION 4 – IN CASE OF AN EMERGENCY

This section explains what to do in the event of an urgent situation such as the engine not starting or getting a flat tire, etc. If such a problem occurs, check the contents of this Owner's Manual and follow the instructions given.

SECTION 5 – MAINTENANCE

This section explains the importance of regular maintenance. Regular and periodic inspection and maintenance of your Lexus will help to keep your vehicle in its best condition.

SECTION 6 – SERVICE PROCEDURES AND SPECIFICATIONS

Simple maintenance procedure and service data are provided here for your reference should you wish to perform inspection and maintenance yourself.

HOW TO USE THIS MANUAL

INDEX

The page number is listed for each item in the Owner's Manual so that you can rapidly find the item and page you are searching for.

GAS STATION INFORMATION

The information you need to know for appropriate servicing at the gas station is provided here.

QUICK INDEX

This is designed so that you can quickly find the needed information when an urgent situation arises.

Safety symbol

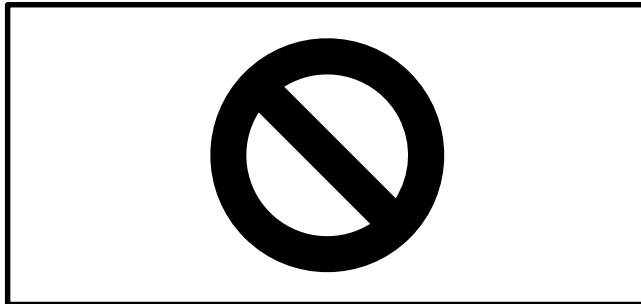

In this manual, you will also see a circle with a slash through it. This means "Do not", "Do not do this", or "Do not let this happen".

Safety and vehicle damage warnings

In this manual you will see CAUTION and NOTICE warnings. These are used in the following ways:

**CAUTION**

This is a warning against anything which may cause injury to people if the warning is ignored. You are informed about what you must or must not do in order to reduce the risk of injury to yourself and others.

NOTICE

This is a warning against anything which may cause damage to the vehicle or its equipment if the warning is ignored. You are informed about what you must or must not do in order to avoid or reduce the risk of damage to your Lexus and its equipment.

Your Lexus Owner's Manual provides you with a considerable amount of information. To use this information most effectively, please take the time to familiarize yourself with the contents and use of the manual.

PICTORIAL INDEX

INSTRUMENT PANEL

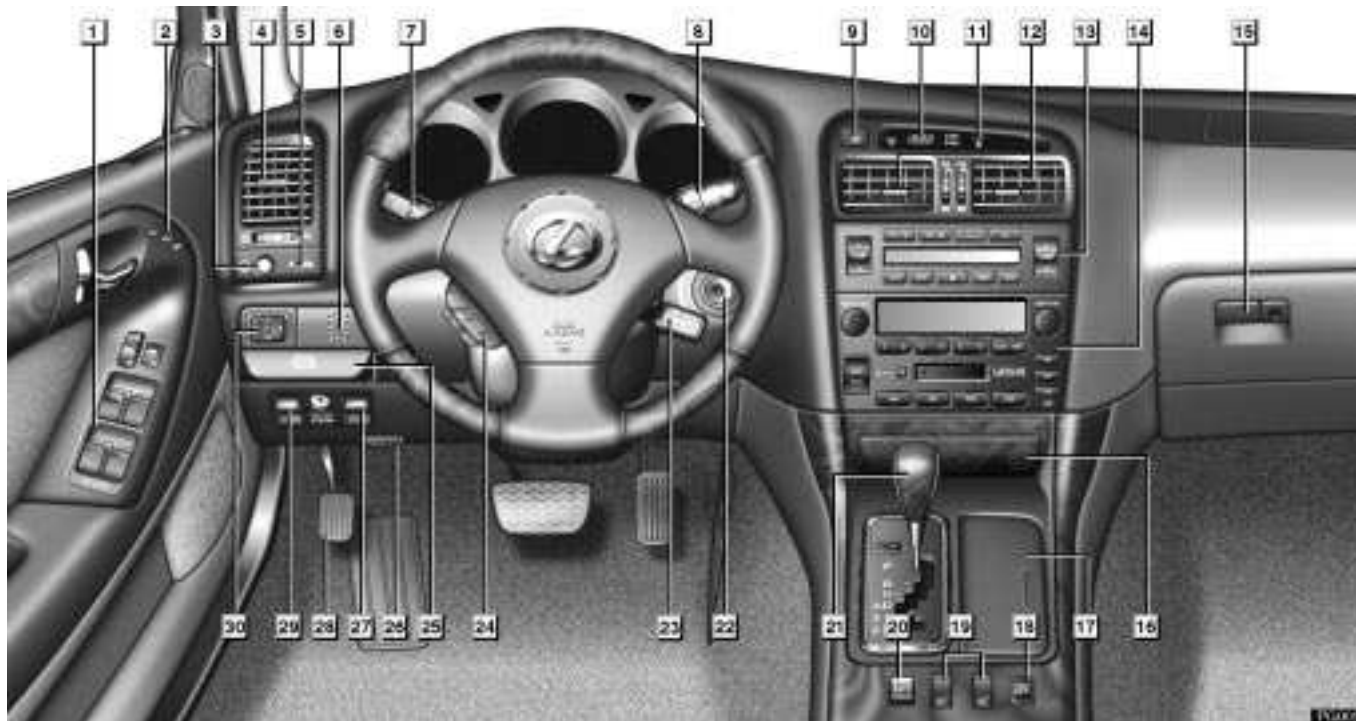

PICTORIAL INDEX

		<i>Page</i>			<i>Page</i>
1	Door lock switch and power window switches	20, 32	15	Glove box/CD automatic changer	57/164
2	Driving position memory switch	130	16	Ashtray	55
3	Instrument panel light control	50	17	Cup holders	61
4	Side vents	148	18	Vehicle stability control system OFF switch	194
5	Security indicator light	134	19	Seat heater switches	35
6	Coin box (Vehicles sold in U.S.A.)	62	20	Driving pattern selector switch	181
	Headlight cleaner switch (Vehicles sold in Canada)	30	21	Automatic transmission selector lever	181
7	Headlight, turn signal and fog light switches	24, 26, 27	22	Ignition switch	178
8	Wiper and washer switches	28	23	Cruise control switch	190
9	Emergency flasher switch	35	24	Steering pad switch	169
10	Clock	54	25	Parking brake release lever	179
11	Front passenger's seat belt reminder light	43	26	Hood lock release lever	66
12	Center vents	148	27	Trunk lid opener	67
13	Automatic air conditioning controls	138	28	Parking brake	179
14	Car audio	152	29	Fuel filler door opener	69
			30	Power rear view mirror control switches	82

For detailed information, refer to the description given in each Section.

PICTORIAL INDEX

INSTRUMENT CLUSTER (GS430 sold in U. S. A.)

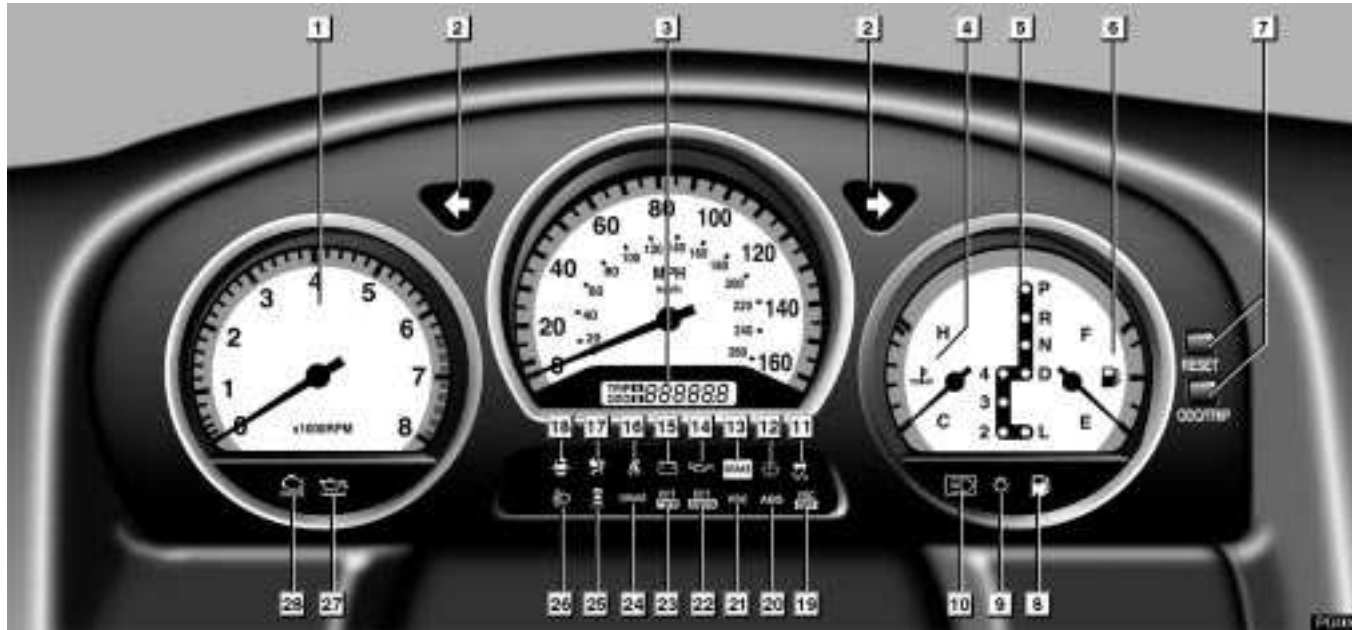

PICTORIAL INDEX

		<i>Page</i>			<i>Page</i>
1	<i>Tachometer</i>	39	16	<i>Driver's seat belt reminder light</i>	43
2	<i>Turn signal indicator light</i>	26	17	<i>SRS warning light</i>	44
3	<i>Odometer and trip meter</i>	40	18	<i>Open door warning light</i>	48
4	<i>Engine coolant temperature gauge</i>	38	19	<i>Vehicle stability control system OFF indicator light</i>	194
5	<i>Automatic transmission indicator lights</i>	181	20	<i>Anti-lock brake system warning light</i>	47
6	<i>Fuel gauge</i>	38	21	<i>Vehicle stability control system warning light</i>	195
7	<i>ODO/TRIP, RESET button</i>	40	22	<i>Snow mode indicator light</i>	189
8	<i>Low fuel level warning light</i>	48	23	<i>Power mode indicator light</i>	189
9	<i>Headlight indicator light</i>	24	24	<i>Cruise control indicator light</i>	190
10	<i>Headlight high beam indicator light</i>	26	25	<i>Rear light failure warning light</i>	48
11	<i>Slip indicator light</i>	193, 194	26	<i>Automatic headlight leveling system warning light</i>	48
12	<i>Low washer fluid warning light</i>	48	27	<i>Low engine oil level warning light</i>	45
13	<i>Brake system warning light</i>	42	28	<i>Malfunction indicator lamp</i>	46
14	<i>Low engine oil pressure warning light</i>	45			
15	<i>Discharge warning light</i>	44			

For detailed information, refer to the description given in each Section.

PICTORIAL INDEX

INSTRUMENT CLUSTER (GS300 sold in U. S. A.)



x

2003 GS430/300 from May '03 Prod. (OM30601U)

PICTORIAL INDEX

		<i>Page</i>			<i>Page</i>
1	<i>Tachometer</i>	39	16	<i>Discharge warning light</i>	44
2	<i>Turn signal indicator light</i>	26	17	<i>Driver's seat belt reminder light</i>	43
3	<i>Shift position indicator for manual control</i>	185	18	<i>SRS warning light</i>	44
4	<i>Odometer and trip meter</i>	40	19	<i>Open door warning light</i>	48
5	<i>Engine coolant temperature gauge</i>	38	20	<i>Vehicle stability control system OFF indicator light</i>	194
6	<i>Automatic transmission indicator lights</i>	181	21	<i>Anti-lock brake system warning light</i>	47
7	<i>Fuel gauge</i>	38	22	<i>Vehicle stability control system warning light</i>	195
8	<i>ODO/TRIP, RESET button</i>	40	23	<i>Snow mode indicator light</i>	189
9	<i>Low fuel level warning light</i>	48	24	<i>Power mode indicator light</i>	189
10	<i>Headlight indicator light</i>	24	25	<i>Cruise control indicator light</i>	190
11	<i>Headlight high beam indicator light</i>	26	26	<i>Rear light failure warning light</i>	48
12	<i>Slip indicator light</i>	193, 194	27	<i>Automatic headlight leveling system warning light</i>	48
13	<i>Low washer fluid warning light</i>	48	28	<i>Low engine oil level warning light</i>	45
14	<i>Brake system warning light</i>	42	29	<i>Malfunction indicator lamp</i>	46
15	<i>Low engine oil pressure warning light</i>	45			

For detailed information, refer to the description given in each Section.

PICTORIAL INDEX

INSTRUMENT CLUSTER (GS430 sold in Canada)

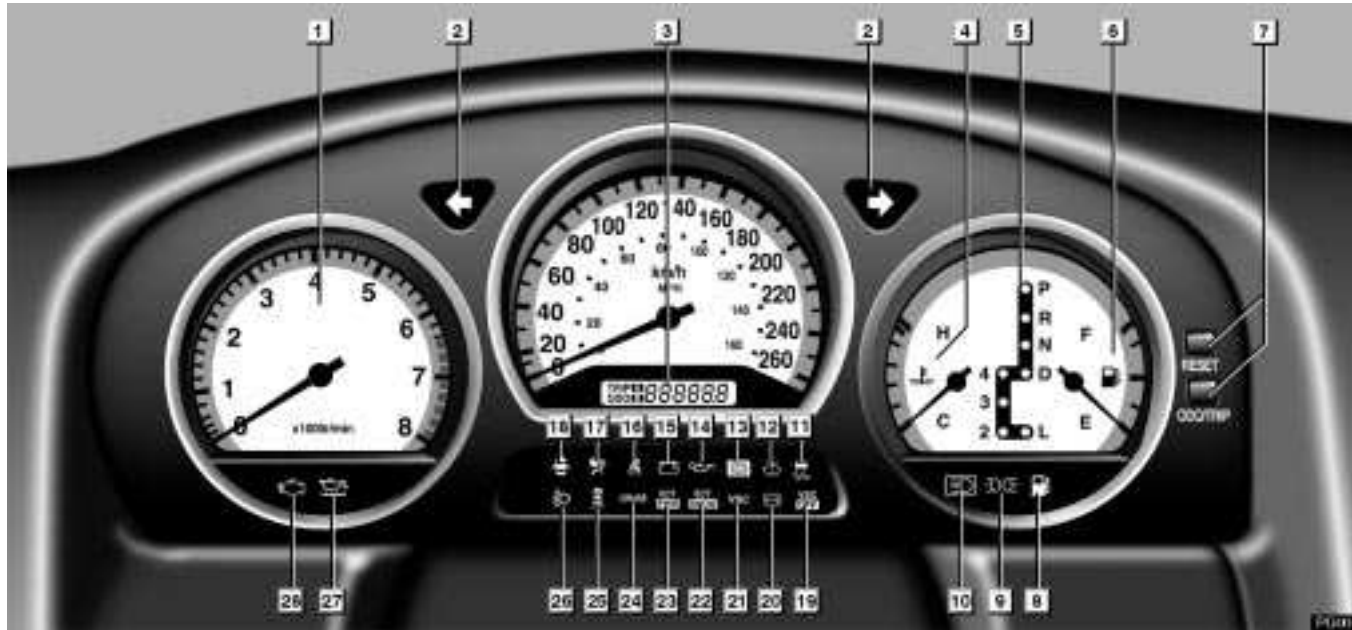

PICTORIAL INDEX

		<i>Page</i>			<i>Page</i>
1	<i>Tachometer</i>	39	16	<i>Driver's seat belt reminder light</i>	43
2	<i>Turn signal indicator light</i>	26	17	<i>SRS warning light</i>	44
3	<i>Odometer and trip meter</i>	40	18	<i>Open door warning light</i>	48
4	<i>Engine coolant temperature gauge</i>	38	19	<i>Vehicle stability control system OFF indicator light</i>	194
5	<i>Automatic transmission indicator lights</i>	181	20	<i>Anti-lock brake system warning light</i>	47
6	<i>Fuel gauge</i>	38	21	<i>Vehicle stability control system warning light</i>	195
7	<i>ODO/TRIP, RESET button</i>	40	22	<i>Snow mode indicator light</i>	189
8	<i>Low fuel level warning light</i>	48	23	<i>Power mode indicator light</i>	189
9	<i>Tail light indicator light</i>	24	24	<i>Cruise control indicator light</i>	190
10	<i>Headlight high beam indicator light</i>	26	25	<i>Rear light failure warning light</i>	48
11	<i>Slip indicator light</i>	193, 194	26	<i>Automatic headlight leveling system warning light</i>	48
12	<i>Low washer fluid warning light</i>	48	27	<i>Low engine oil level warning light</i>	45
13	<i>Brake system warning light</i>	42	28	<i>Malfunction indicator lamp</i>	46
14	<i>Low engine oil pressure warning light</i>	45			
15	<i>Discharge warning light</i>	44			

For detailed information, refer to the description given in each Section.

PICTORIAL INDEX

INSTRUMENT CLUSTER (GS300 sold in Canada)

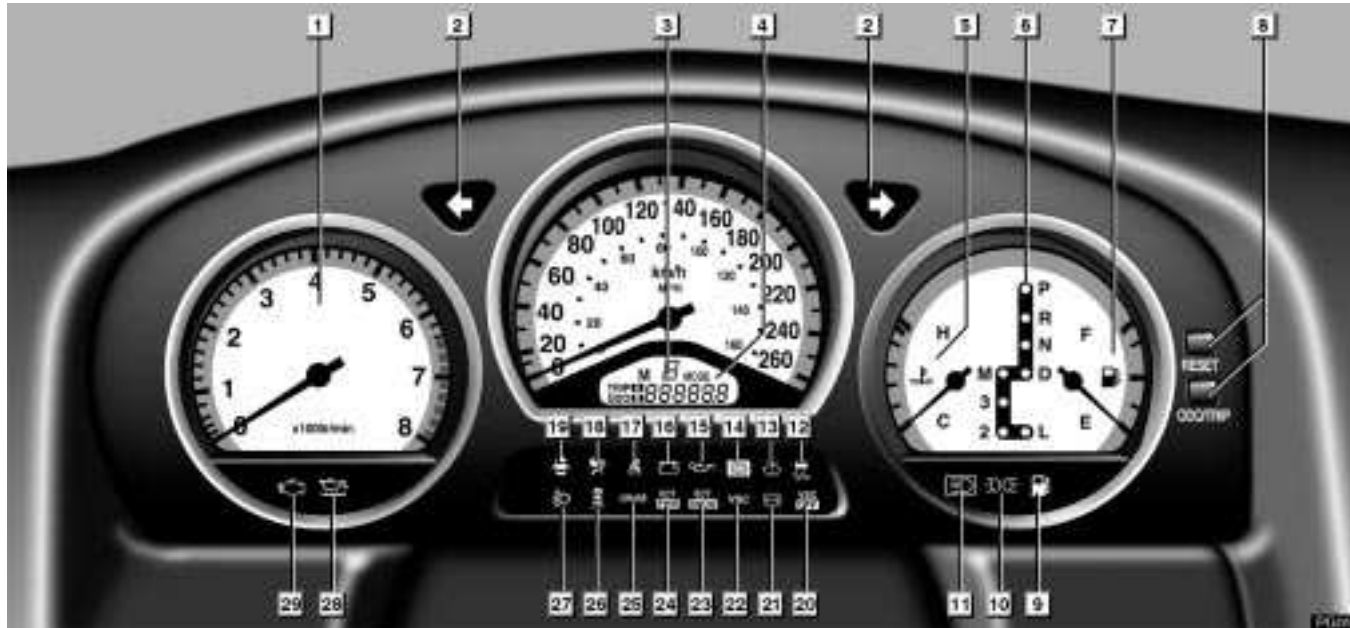

PICTORIAL INDEX

		<i>Page</i>			<i>Page</i>
1	<i>Tachometer</i>	39	16	<i>Discharge warning light</i>	44
2	<i>Turn signal indicator light</i>	26	17	<i>Driver's seat belt reminder light</i>	43
3	<i>Shift position indicator for manual control</i>	185	18	<i>SRS warning light</i>	44
4	<i>Odometer and trip meter</i>	40	19	<i>Open door warning light</i>	48
5	<i>Engine coolant temperature gauge</i>	38	20	<i>Vehicle stability control system OFF indicator light</i>	194
6	<i>Automatic transmission indicator lights</i>	181	21	<i>Anti-lock brake system warning light</i>	47
7	<i>Fuel gauge</i>	38	22	<i>Vehicle stability control system warning light</i>	195
8	<i>ODO/TRIP, RESET button</i>	40	23	<i>Snow mode indicator light</i>	189
9	<i>Low fuel level warning light</i>	48	24	<i>Power mode indicator light</i>	189
10	<i>Tail light indicator light</i>	24	25	<i>Cruise control indicator light</i>	190
11	<i>Headlight high beam indicator light</i>	26	26	<i>Rear light failure warning light</i>	48
12	<i>Slip indicator light</i>	193, 194	27	<i>Automatic headlight leveling system warning light</i>	48
13	<i>Low washer fluid warning light</i>	48	28	<i>Low engine oil level warning light</i>	45
14	<i>Brake system warning light</i>	42	29	<i>Malfunction indicator lamp</i>	46
15	<i>Low engine oil pressure warning light</i>	45			

For detailed information, refer to the description given in each Section.

PICTORIAL INDEX

SEAT AND STEERING WHEEL

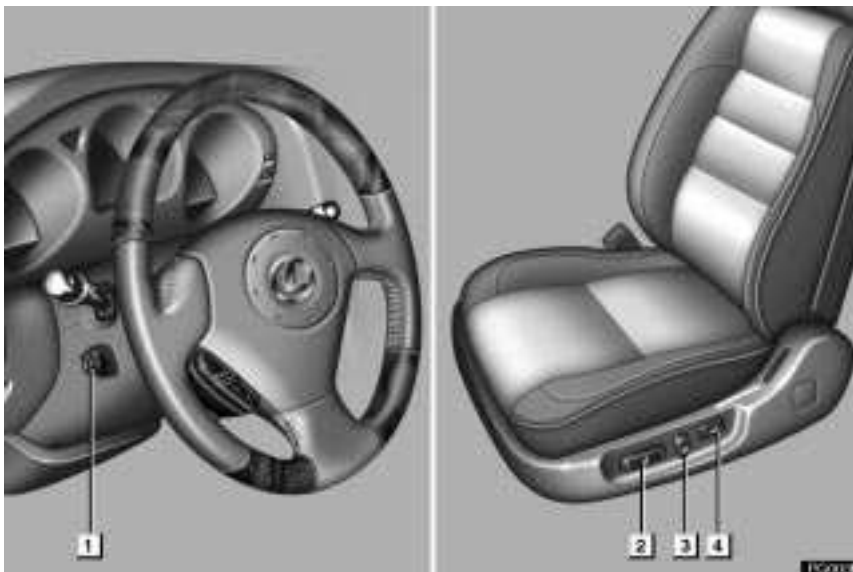

	<i>Page</i>
1 <i>Tilt and telescopic steering adjustment switch</i>	80
2 <i>Seat position, seat cushion angle and height control switch</i>	77, 78
3 <i>Seatback angle control switch</i> ...	77
4 <i>Lumbar support control switch</i> ..	78

For detailed information, refer to the description given in each Section.

EXTERIOR VIEW



	<i>Page</i>
1 <i>Rear window defogger</i>	31
2 <i>Trunk lid</i>	67
3 <i>Moon roof</i>	70
4 <i>Wiper and washer</i>	28, 303
5 <i>Fuel filler door</i>	69
6 <i>Outside rear view mirror</i>	82
7 <i>Door</i>	19
8 <i>Tire and wheel</i>	282
9 <i>Headlights</i>	24, 309
10 <i>Hood</i>	66

For detailed information, refer to the description given in each Section.

FIGURE

BASIC OPERATION

QUICK REFERENCE

Driver's seat	2
Steering wheel	2
Automatic transmission (GS430)	3
Automatic transmission (GS300)	4
Headlight and turn signal switches	5
Wiper switch	6

QUICK REFERENCE

1. DRIVER'S SEAT

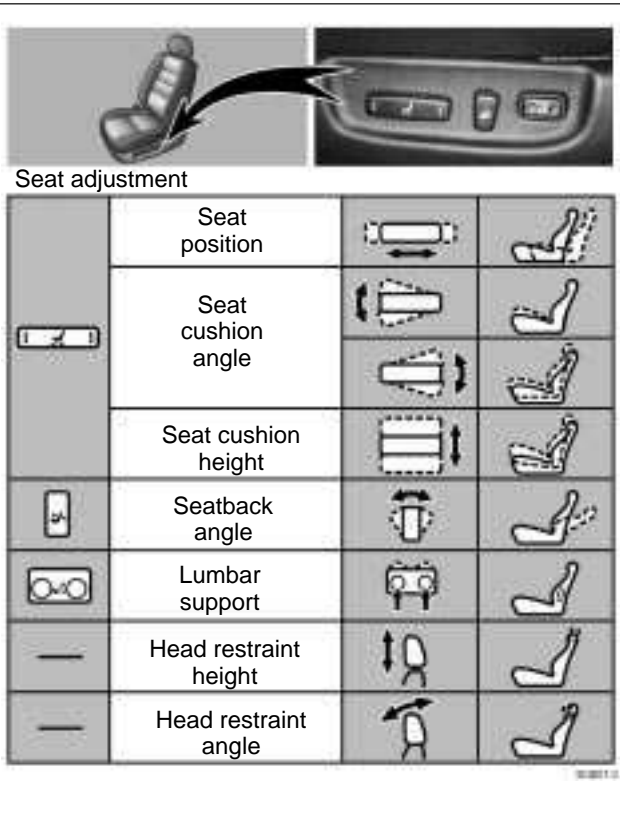

Seat adjustment

	Seat position		
	Seat cushion angle		
	Seat cushion height		
	Seatback angle		
	Lumbar support		
	Head restraint height		
	Head restraint angle		

2. STEERING WHEEL

- TILT STEERING WHEEL

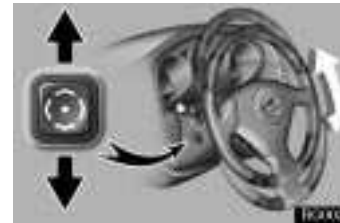

To tilt the steering wheel up or down to the desired angle, push the control switch in the required direction and release the button when the steering wheel reaches the desired angle.

- TELESCOPIC STEERING WHEEL



To move the steering wheel to the desired position, push the control switch away from you or pull it toward you until the steering wheel reaches the desired position.

3. AUTOMATIC TRANSMISSION(GS430)



SELECTOR LEVER POSITION

- P:** Parking, engine starting and key removal
- R:** Reverse
- N:** Neutral
- D:** Normal driving (with overdrive on)
- 4:** Engine braking*
- 3, 2:** Stronger engine braking
- L:** Maximum engine braking

OPERATION OF SELECTOR LEVER



★ Shift while pressing the brake pedal. (Ignition switch must be in the "ON" position.)

*When the cruise control is being used, even if you downshift from "D" to "4", engine braking will not be enabled because the cruise control is not cancelled. For the operation to decrease the vehicle speed, see page 192.

QUICK REFERENCE

AUTOMATIC TRANSMISSION(GS300)



SELECTOR LEVER POSITION

- P:** Parking, engine starting and key removal
- R:** Reverse
- N:** Neutral
- D:** Normal driving (with overdrive on)
- M:** Manual shifting up or down shifting*
- 3, 2:** Stronger engine braking
- L:** Maximum engine braking

OPERATION OF SELECTOR LEVER





- ★ Shift while pressing the brake pedal. (Ignition switch must be in the "ON" position.)

*When the cruise control is being used, even if you downshift from "D" to "4", engine braking will not be enabled because the cruise control is not cancelled. For the operation to decrease the vehicle speed, see page 192.



4. HEADLIGHT AND TURN SIGNAL SWITCHES



● HEADLIGHT SWITCH

With the ignition OFF



	Parking, tail, license plate, side marker and instrument panel lights turn on.
	Headlights also turn on.
	Automatic light control

With the engine started and parking brake released

	Parking, tail, license plate, side marker and instrument panel lights turn on.
	Headlights also turn on at full intensity.
	Automatic light control





	High beam
	Headlight flasher

● TURN SIGNAL SWITCH

	Right or left turn
	Lane change (Right or left)

QUICK REFERENCE

5. WIPER SWITCH

	Mist wiper operation
	Intermittent operation
	Low speed operation
	High speed operation
	Washer on

SECTION 1 - 1

INSTRUMENTS AND CONTROLS

Keys and doors

Keys	8
Engine immobiliser system	11
Wireless remote control	13
Doors	19

KEYS AND DOORS

KEYS

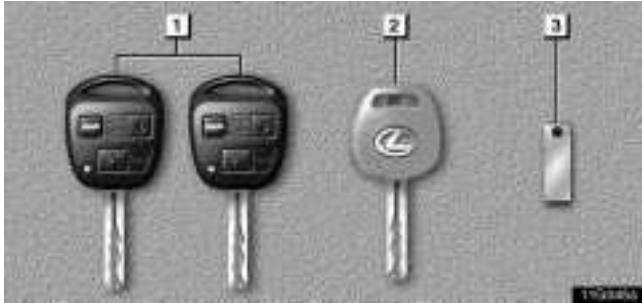

- 1** Master keys (black) – These keys work in every lock. For your Lexus dealer to make a new key with a built-in transponder chip, your dealer will need one of them.
- 2** Sub key (gray) – This key will not open the trunk, trunk main switch and the glove box. For your Lexus dealer to make a new key with built-in transponder chip, your dealer will need it.
- 3** Key number plate – Keep the plate in a safe place such as your wallet, not in the vehicle.

A transponder chip for the engine immobiliser system has been placed in the head of the master and sub keys. These chips are required for the system to function correctly, so be careful not to lose these keys. If you make your own duplicate key, you will not be able to cancel the system or start the engine.

To protect items locked in the trunk or glove box when using valet parking, leave the sub key with the attendant.

Since the doors and trunk lid can be locked without a key, you should always carry a spare master key in case you accidentally lock your keys inside the vehicle.

If you should lose your keys or if you need additional keys, duplicates can be made by a Lexus dealer using the key number.

We recommend writing down the key number and storing it in a safe place.

Flat key

As a transponder chip is built in its key case, you can start the engine with this key.

The flat key works in every lock.

A transponder chip for the engine immobiliser system has been placed in the key case of the flat key. This chip is required for the system to function correctly, so be careful not to lose this key. If you make your own duplicate key, you will not be able to cancel the system or start the engine.

Insert your key plate in its key case as shown. We recommend that you always carry this with you for emergency use. Do not leave it in your vehicle.

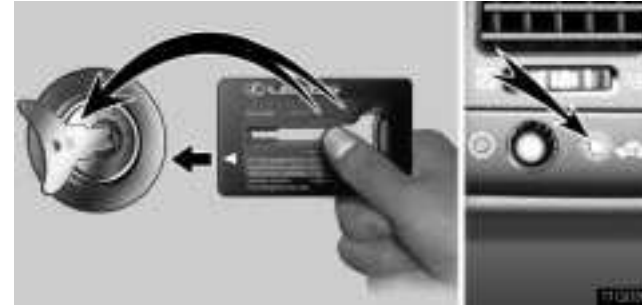
Starting the engine using a flat key

1. Remove the key plate from the key case.
2. Insert the key plate into the ignition switch. The indicator light keeps flashing.
3. Bring the key case closer to the ignition switch within 10 seconds as indicated by the arrow head. The indicator light goes out. This means the engine immobiliser system is automatically canceled. (For details, see "Engine immobiliser system" on page 11.) You can put the key case away then. You cannot cancel the engine immobiliser system if 10 seconds have passed after you inserted the key plate. You need to remove the key plate from the ignition switch and try it again from the step 2.
4. Start the engine within 60 seconds after the security indicator light goes out. You cannot start the engine if 60 seconds have passed after the security indicator went off. You need to remove the key plate from the ignition switch and try it again from the step 2.

KEYS AND DOORS

NOTICE

- Do not let the key case become bent as the key plate may fall out or become bent also.
- The flat key is designed for emergency use only. So do not use it regularly instead of other master keys.



When using a key containing a transponder chip, observe the following precautions:

- When starting the engine, do not use the key with a key ring resting on the key grip and do not press the key ring against the key grip. Doing so may prevent the engine from starting, or may cause the engine to stop soon after it starts.



- When starting the engine, do not use the key in proximity with other transponder keys (including the flat key and keys of other vehicles), and do not press other key plates against the key grip. Doing so may prevent the engine from starting, or may cause the engine to stop soon after it starts. If this happens, remove the key once and then insert it again after removing other transponder keys (including the flat key and keys of other vehicles) from the ring or while gripping or covering them with your hand to start the engine.



- ***Do not bend the key grip or flat key.***
- ***Do not cover the key grip or flat key with any material that cuts off electromagnetic waves.***
- ***Do not knock the key or flat key hard against other objects.***
- ***Do not leave the key or flat key exposed to high temperatures for a long period, such as on the dashboard or hood under direct sunlight.***
- ***Do not put the key or flat key in water or wash it in an ultrasonic washer.***
- ***Do not use the key or flat key with electromagnetic materials.***

ENGINE IMMOBILISER SYSTEM



The engine immobiliser system is a theft prevention system. When you insert the key in the ignition switch, the transponder chip in the key's head transmits an electronic code to the vehicle. The engine will start only when the electronic code in the chip corresponds to the registered ID code for the vehicle.

The system is automatically set when the key is removed from the ignition switch. At this time, the security indicator light flashes. When you insert the key in the ignition switch, the security indicator light goes out and the system is canceled automatically, which enables the engine to start.

The transponder chip of the flat key is in its key case. You can cancel the engine immobiliser system using the flat key. (For details, see "Flat key" on page 9.)

KEYS AND DOORS

For your Lexus dealer to make you a new key with built-in transponder chip, your dealer will need your key number and master key or the flat key. However, there is a limit to the number of additional keys your Lexus dealer can make for you.

If you make your own duplicate key, you will not be able to cancel the system or start the engine.

For vehicles sold in U.S.A.

**FCC ID: MOZ RI-4ATY
MADE IN JAPAN**

This device complies with Part 15 of the FCC Rules. Operation is subject to the following two conditions:
(1) This device may not cause harmful interference, and (2) this device must accept any interference received, including interference that may cause undesired operation.



CAUTION

Changes or modifications not expressly approved by the party responsible for compliance could void the user's authority to operate the equipment.

For vehicles sold in Canada

This device complies with RSS-210 of Industry Canada. Operation is subject to the following two conditions:

(1) This device may not cause interference, and (2) this device must accept any interference, including interference that may cause undesired operation of the device.

WIRELESS REMOTE CONTROL*



- 1 Locking the doors and sounding an alarm**
- 2 Unlocking the doors and opening the windows and moon roof**
- 3 Indicator light**
- 4 Unlocking the trunk lid**

*NOTE: *This feature can be deactivated as vehicle theft deterrent measure in case of the loss of the wireless remote control key. Ask your Lexus dealer for details.*

When you operate any button on the key, push it slowly and surely. At this time, the indicator light on the key grip flashes once.

The operational range of the wireless remote control is approximately 1 meter (3 ft.). The effective range may vary with different conditions. To activate the wireless remote control without fail, do it approximately 1 meter (3 ft.) from your Lexus.

In the following cases, the battery in the key may be discharged. If this is the case, replace it using a special screwdriver.

- The remote control does not work.
- The operational range of wireless remote control becomes extremely short.
- The indicator light on the key is dimmed or does not come on.

For the replacement of the battery, see "Replacing the battery" on page 17. You can also have the battery of the key replaced by your Lexus dealer.

If you lose the wireless key, contact your Lexus dealer as soon as possible to avoid the possibility of theft, or an accident.

You can use up to 4 wireless remote control keys for the same vehicle. Contact your Lexus dealer for detailed information.

The wireless remote control key is an electronic component. Observe the following instructions in order not to cause damage to the key.

- Do not leave the wireless remote control key on places where the temperature becomes high such as on the dashboard.
- Do not disassemble it.
- Avoid knocking it hard against other objects or dropping it.
- Avoid putting it in water.

KEYS AND DOORS

Locking/Unlocking the doors

When you push the "LOCK" button on the key briefly, all the doors can be locked from outside the vehicle.

When they are locked securely, the emergency flashers will flash and one beep will sound.* However, when you push the "LOCK" button with any door not closed securely, the buzzer sounds for 10 seconds.** To stop the buzzer, close all the doors securely or push the "UNLOCK" button. If the key is in the ignition switch, locking cannot be done.

Make sure all the doors are locked when you leave the vehicle. Push the "LOCK" button once again. If they were already locked, the turn signal lights will flash.***

*NOTE: *The emergency flashers can be set not to flash and beep volume can be changed. **The buzzer can be set not to sound if a door is not closed securely. ***The turn signal lights can be set not to flash. Ask your Lexus dealer for details.*

NOTICE

Do not push the "LOCK" button any longer than 2 to 3 seconds. Pushing the button longer activates an alarm. For details, see page 15.

When you push the "UNLOCK" button, the driver's door is unlocked. Pushing that button once again within 3 seconds from the first push, all other doors are also unlocked.*

*NOTE: *The 2-step unlocking function can be changed. Ask your Lexus dealer for details.*

At this time, the emergency flashers will flash twice and two beeps will sound.* Together with the activation of unlocking, the interior light comes on for 15 seconds if the interior light switch is in "DOOR" position.** However, this function does not work when the ignition key is in the "ON" position. For further information, see "Interior lights" on page 53.

You have 30 seconds to open a door after using the wireless remote unlock feature.*** If a door is not opened by then, all the doors will be automatically locked again.

Even if the "LOCK" or "UNLOCK" button is kept pressed in, the locking or unlocking operation is not repeated. Release the button and then push again.

*NOTE: *The emergency flashers can be set not to flash and beep volume can be changed. **The interior light can be set not to come on or the duration of lighting can be changed. ***The time before automatic re-locking can be changed. Ask your Lexus dealer for details.*

Unlocking the trunk lid



When you keep the button pushed for about 1 second, you can unlock the trunk lid.* One beep sounds.

This function does not work when the ignition key is in the "ON" position.

*NOTE: *The operation method can be changed. Ask your Lexus dealer for details.*

Sounding an alarm*



When you push the "PANIC" button for about 2 to 3 seconds, an alarm sounds to deter any person trying to break into or damage your vehicle.

If you want to stop the alarm, push any button.

This function does not work when the ignition key is in the "ON" position.

*NOTE: *The alarm can be set not to sound. Ask your Lexus dealer for details.*

KEYS AND DOORS

Operating the windows and moon roof

The windows and moon roof can be operated using a wireless key from outside the vehicle.*

*NOTE: *The windows can be deactivated. The moon roof can be set to slide open, tilt up or deactivated. Ask your Lexus dealer for details.*



Push the "UNLOCK" button until the windows and moon roof start to move. When you release the button, the windows and moon roof stop operating.

This function will work even with the window lock switch pressed in.

For vehicles sold in U.S.A.

This device complies with Part 15 of the FCC Rules. Operation is subject to the following two conditions: (1) This device may not cause harmful interference, and (2) this device must accept any interference received, including interference that may cause undesired operation.

NOTICE:

This equipment has been tested and found to comply with the limits for a Class B digital device, pursuant to Part 15 of the FCC Rules. These limits are designed to provide reasonable protection against harmful interference in a residential installation. This equipment generates, uses and can radiate radio frequency energy and, if not installed and used in accordance with the instructions, may cause harmful interference to radio communications. However, there is no guarantee that interference will not occur in a particular installation. If this equipment does cause harmful interference to radio or television reception, which can be determined by turning the equipment off and on, the user is encouraged to try to correct the interference by one or more of the following measures:

- Reorient or relocate the receiving antenna.
- Increase the separation between the equipment and receiver.
- Connect the equipment into an outlet on a circuit different from that to which the receiver is connected.

- Consult the dealer or an experienced radio / TV technician for help.

FCC WARNING:
Changes or modifications not expressly approved by the party responsible for compliance could void the user's authority to operate the equipment.

For vehicles sold in Canada

Operation is subject to the following two conditions: (1) this device may not cause interference, and (2) this device must accept any interference, including interference that may cause undesired operation of the device.

Replacing the battery

When you replace the battery, prepare a lithium battery CR1616 or equivalent and a special screwdriver.

CAUTION

Special care should be taken to prevent small children from swallowing the removed battery or components.

NOTICE

- *When replacing the battery, be careful not to lose the components, screws and O-ring.*
- *Replace only with the same or equivalent type recommended by a Lexus dealer.*
- *Dispose of used batteries according to the local laws.*



1. Remove the screw, and then the cover while pushing it in the arrow direction.

KEYS AND DOORS



2. Remove the module from the key frame.



3. Remove the 2 screws to take out the lid of the module.

4. Take out the discharged battery and put a new battery with the positive side up.

NOTICE

- *Make sure the positive side and negative side of the battery are faced correctly.*
- *Do not replace the battery with wet hands. Water may cause unexpected rust.*
- *Do not touch or move any components inside the transmitter, or it may interfere with proper operation.*
- *Be careful not to bend the electrode of the battery insertion and that dust or oils do not adhere to the inside of the module.*
- *Take care not to lose the screws and O-ring.*

5. Install the lid with the 2 screws.

NOTICE

Take care not to damage or bend the O-ring when installing.

6. Install the module into the key frame and secure the cover with the screw.

7. When pushing any switch on the wireless key, make sure the indicator light comes on.

DOORS

Locking with key



► **1** Lock **2** Unlock

Turn the key towards the front of the vehicle to lock and towards the back to unlock.

The doors lock and unlock simultaneously with either front door. In the driver's door lock, turning the key once will unlock the driver's door and twice in succession will unlock all doors simultaneously.* In the passenger's door lock, turning the key once will unlock all doors simultaneously.

*NOTE: *The 2-step unlocking function can be changed. Ask your Lexus dealer for details.*

If a wrong key is used, the key cylinder rotates freely to isolate inside mechanism. So, door locking is protected from thieves.

The windows and moon roof can be opened and closed from outside the vehicle using the key. For details, see "Power window switches" on page 32 and "Moon roof" on page 70.

Locking with inside lock button



► **1** Lock **2** Unlock

Push in the lock button to lock and unlock the door.

The front doors can be opened by pulling the inside handles even if the lock buttons are in the locked position.



CAUTION

Do not pull the inside handle of the front doors while driving. The doors will open and an accident may occur. Lexus strongly recommends that all children be placed in the rear seat of the vehicle.

KEYS AND DOORS

Closing the door with the lock button pushed in will also lock the door. Be careful not to lock your keys in the vehicle. Doors cannot be locked when either front door is open and the key is in the ignition.

If the vehicle is subjected to a severe frontal, rear or side impact with the ignition switch turned to the "ON" position, all the doors will unlock automatically after a few seconds.

CAUTION

Before driving, make sure the doors are closed and locked, especially when small children are in the vehicle. Along with the proper use of seat belts, locking the doors helps prevent the driver and passengers from being thrown out from the vehicle during an accident. It also helps prevent the doors from being opened unintentionally.

Locking with power door lock switch



► **1** Lock **2** Unlock

To lock all the doors simultaneously, push the power door lock switch down on the front side. Pushing down on the rear side will unlock them.

The same switch is also found on the front passenger's side.

Auto door locking function*: All the doors will lock automatically when the selector lever is moved out of "P" position. This auto door locking function is operable while the ignition switch is turned to the "ON" position.

*NOTE: * This auto door locking function can be disabled or changed. Ask your Lexus dealer for details.*

Locking with rear door child-protector



► **1** *Unlock* **2** *Lock*

Whenever small children are in the vehicle, lock the rear door so that it does not open from the inside. To do this, turn the knob to the "LOCK" position as shown and then close the door.

SECTION 1-2

INSTRUMENTS AND CONTROLS

Switches

Headlight switch	24
Headlight dimmer and turn signal switches	26
Fog light switch	27
Windshield wiper and washer switches	28
Headlight cleaner switch	30
Rear window and outside rear view mirror defogger switch	31
Power window switches	32
Emergency flasher switch	35
Seat heater switches	35

SWITCHES

HEADLIGHT SWITCH

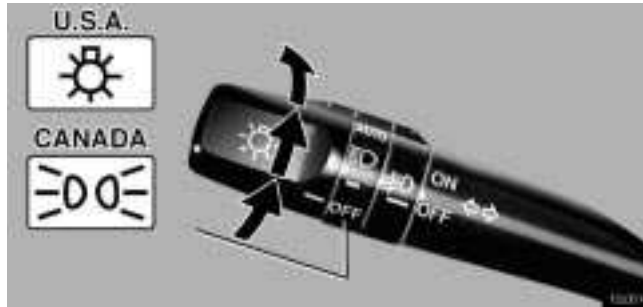

To turn the lights on, twist the knob on the end of the lever.

FIRST CLICKSTOP: Only the parking, tail, license plate, side marker and instrument panel lights turn on.

SECOND CLICKSTOP: Headlights also turn on.

THIRD CLICKSTOP ("AUTO"): The headlights and all other lights automatically turn on depending on the darkness of the surroundings.*

Vehicles sold in U.S.A.: When the headlights are on, the headlight indicator lights up in the instrument cluster.

Vehicles sold in Canada: When the tail lights are on, the tail light indicator lights up in the instrument cluster.

Manually twist the knob to the second clickstop to turn on the headlights if they are needed immediately when entering a dark tunnel, parking structure, etc.

When the headlight switch is turned to the first or second clickstop, the brightness of the instrument cluster will be reduced slightly unless the instrument panel light control knob is turned fully on.

*NOTE: *The operating condition or sensitivity can be changed. Ask your Lexus dealer for details.*



The automatic light control sensor is on top of the driver's side instrument panel.

Do not place anything on the instrument panel, and/or do not affix anything on the windshield to block this sensor.

When the headlights come on, the lights automatically turn off about 30 seconds after any of the doors is opened and closed with the ignition key turned to the "ACC" or "LOCK" position.* To turn them on again, turn the ignition key to the "ON" position, or turn the headlight switch off and then twist the knob until the first or second clickstop. If you are going to park for over one week, make sure the headlight switch is off.

When the headlight switch is on with all the doors locked, pushing the "LOCK" button on the wireless remote control key turns off the headlights.

*NOTE: *The time before turning off the lights can be changed. Ask your Lexus dealer for details.*

Daytime Running Light System

The headlights turn on at reduced intensity when the parking brake is released with the engine started, even with the light switch in the "OFF" position. They will not go off until the ignition switch is turned off.

To turn on the other exterior lights and instrument panel lights, twist the knob to the first clickstop.

Twist the knob to the second clickstop to turn on the headlights to full intensity for driving at night.

When setting the knob to the third clickstop ("AUTO"), the headlights will automatically adjust to full intensity and/or turn on the other lights depending on the darkness of the surroundings. Likewise, as the surroundings become brighter, the headlights will turn to reduced intensity, ultimately turning off the other lights.

NOTICE

To prevent the battery from being discharged, do not leave the lights on longer than necessary when the engine is not running.

SWITCHES

Automatic headlight leveling system (Vehicles with discharge headlight only)



The headlight beam level is always maintained automatically at the proper level in all loading conditions so that your headlights do not dazzle other road users.

If this system fails, the warning light in the instrument cluster comes on. If this occurs, have your vehicle checked by Lexus dealer.

HEADLIGHT DIMMER AND TURN SIGNAL SWITCHES



For high beam, push the lever forward. Pull it back for low beam. For the headlight flasher, pull it further back.

A blue light in the instrument cluster indicates high beam or headlight flasher is on.

The headlight flasher works even when the headlight switch is off.



For signaling turns, move the lever up or down in the conventional manner.

The ignition key must be in the "ON" position.

The turn signal is self-cancelling after a turn, but after a lane change, you may have to cancel it by hand. You can also signal a lane change by moving the turn signal lever partway and holding it there.

If the green light in the instrument cluster flashes faster than normal, it indicates that the front or rear turn signal bulb has burned out. If this indicator light does not come on, the fuse or the indicator light itself has probably failed.

FOG LIGHT SWITCH



To turn on the fog lights, turn the switch to the "ON" position. They will come on only when the headlights are on low beam.

SWITCHES

WINDSHIELD WIPER AND WASHER SWITCHES

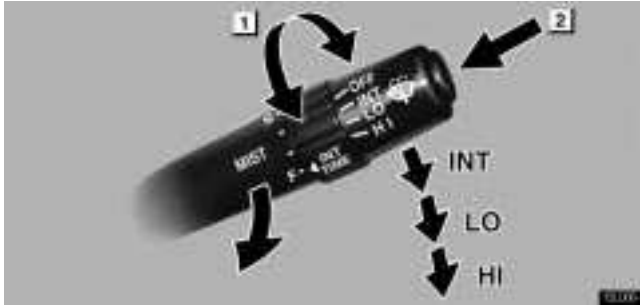

► **1** Interval adjuster **2** Washer on

To turn the wipers on, move the lever down until you reach the desired speed setting.

The ignition key must be in the "ON" position.

There are 3 settings:

"INT" position: Intermittent operation

"LO" position: Low speed operation

"HI" position: High speed operation

Twist the interval adjuster upward to increase the wiping time interval between sweeps, and downward to decrease it.

The wiper lever must be in the "INT" position.

For mist wiper operations (a single wipe), pull the lever toward you and release it.

To make the washer squirt, push the button on the end of the lever.

The low washer fluid warning light in the instrument cluster comes on when the fluid level in the tank becomes very low. For information on adding washer fluid, see "Adding washer fluid" on page 303.

In cold weather, warm the windshield with the defroster before using the washer. This will help prevent icing, which could block your vision.

NOTICE

Do not operate the wipers if the windshield is dry. It may scratch the glass.

Shifting the windshield wiper position

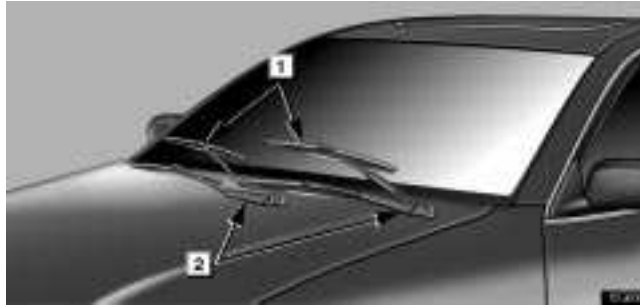

► **1 Rest position** **2 Retracted position**

The wiper blades retract under the hood when the wipers are turned off.

In the following cases, the wipers should be shifted from the retracted position to the rest position above the hood level.

- When cleaning the windshield
- When inspecting or replacing the wipers
- When the retraction may be obstructed by snow, etc., at the bottom of the windshield

Other than the above cases, keep the wipers in the retracted position.



★ *More than 10 cm (3.9 in.)*

To shift the windshield wipers from retracted to rest position, hold the connection of the wiper arm and wiper blade and pull it upward along the windshield glass with the force of about 98 N (10 kgf, 22 lbf.).

NOTICE

To prevent the wiper blades from being deformed, be sure to hold the connection of the wiper arm and wiper blade securely.

SWITCHES



To return the windshield wipers to retracted position, push the connection of the wiper arm and wiper blade downward.

NOTICE

To prevent the wiper blades from being deformed, be sure to hold the connection of the wiper arm and wiper blade securely.

HEADLIGHT CLEANER SWITCH (CANADA ONLY)



To spray fluid on the headlights, push the switch with the headlights on.

The ignition key must be in the "ON" position.

The low washer fluid warning light in the instrument cluster comes on when the fluid level in the tank becomes very low. For information on adding washer fluid, see "Adding washer fluid" on page 303.

NOTICE

Do not turn the headlight cleaner on with the washer fluid tank empty. It may cause the cleaner motor to overheat.

REAR WINDOW AND OUTSIDE REAR VIEW MIRROR DEFOGGER SWITCH



To turn the electric rear window defogger on, push the switch.

The ignition key must be in the "ON" position.

The thin heater wires on the inside of the rear window and the heater panels in the outside rear view mirrors will quickly clear the surface. Keep your hands off the mirror faces when the switch is on. An indicator light is on when the defogger is operating.

The system will automatically shut off when the defogger has operated about 15 minutes.

CAUTION

Since the mirror surfaces can get hot, do not touch them when the switch is on.

If further defrosting or defogging is desired, simply actuate the switch again. When the surface has cleared, push the switch once again to turn the defogger off. Continuous use may cause the battery to discharge, especially during stop-and-go driving. The defogger is not designed to dry rain water or to melt snow.

If the outside rear view mirrors are heavily coated with ice, use a spray de-icer before operating the switch.

NOTICE

- *When cleaning the inside of the rear window, be careful not to scratch or damage the heater wires or connectors.*
- *To prevent the battery from being discharged, turn the switch off when the engine is not running.*

SWITCHES

POWER WINDOW SWITCHES



- ▶ **1** For driver's window
- 2** For front passenger's window
- 3** For left rear window
- 4** For right rear window

To raise or lower the windows, use the switch on each door. The passengers' windows can also be controlled by the switches on the driver's door.

The power windows work when the ignition key is in the "ON" position.

Key off operation: Even if the ignition key is turned to the "ACC" or "LOCK" position, the window can be operated until any of the doors is opened (or for about 45 seconds).

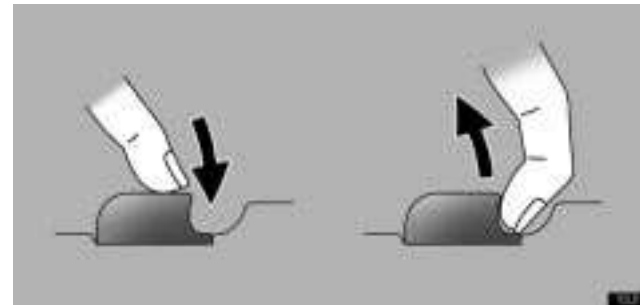

Operating the switches

To raise or lower the window, pull the switch halfway up or push it halfway down.

Automatic operation: To fully raise or lower the window automatically, pull the switch fully up or push it fully down.

To stop the window partway, lightly push or pull the switch in the opposite direction and then release it.

Operating the window lock switch



► Indicator light

With the window lock switch pressed in, only the driver's window can be raised or lowered.

The indicator lights on the switch tell you which of the switches can be operated.

Even with the window lock switch pressed in, the windows will be opened from outside the vehicle using an ignition key or wireless remote control.

Operating the windows from outside the vehicle

The windows can be operated using an ignition key.*

*NOTE: *This feature can be deactivated. Ask your Lexus dealer for details.*

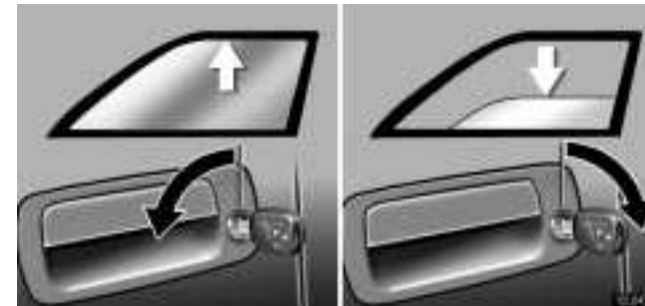

Insert the ignition key into the key hole on the driver's side.

To close the windows: Turn the key in the locking direction and hold it.

After the door is locked, the windows begin to close. To stop in the middle, return the key.

To open the windows: Turn the key in the unlocking direction and hold it.

After the door is unlocked, the windows begin to open. To stop in the middle, return the key.

SWITCHES

This function will work even with the window lock switch pressed in.

Jam protection function

If something gets caught between the window and window frame during automatic raising operation, key off raising operation or raising operation using the ignition key from the outside, the window stops and is lowered.

If the window receives a strong impact, this function may work even if nothing is caught.



CAUTION

To avoid serious personal injury, you must do the following.

- Before you close the power windows, always make sure there is nobody around the power windows. You must also make sure the heads, hands and other parts of the bodies of all occupants are kept completely inside the vehicle. If someone's neck, head or hands get caught in a closing window, it could result in a serious injury. When anyone closes the power windows, make sure he or she operates the windows safely.
- When small children are in the vehicle, never let them use the power window switches without supervision. Use the window lock switch to prevent them from making unexpected use of the switches.

- Be sure to remove the ignition key when you leave your vehicle.
- Never leave anyone (particularly a small child) alone in your vehicle, especially with the ignition key still inserted. Otherwise, he/she could use the power window switches and get trapped in a window. Unattended person (particularly a small child) can be involved in a serious accident.
- Never try jamming any part of your body to activate the jam protection function intentionally.
- The jam protection function may not work if something gets caught just before the window fully closed.

EMERGENCY FLASHER SWITCH



To turn on the emergency flashers, push the switch.

All the turn signal lights will flash. The emergency flashers will work with the engine running or off and with or without the ignition key.

Turn on the emergency flashers to warn other drivers if you must stop your vehicle where it might be a traffic hazard.

Always pull your vehicle as far off the road as possible.

The turn signal light switch will not work when the emergency flashers are in operation.

NOTICE

To prevent the battery from being discharged, do not leave the switch on longer than necessary when the engine is not running.

SEAT HEATER SWITCHES



► **1** For driver's seat **2** For front passenger's seat

There is a heater switch for each front seat. Push the front of the switch to turn the heater on and push the rear side to turn it off.

The ignition key must be in the "ON" position.

SWITCHES



CAUTION

Occupants must use caution when operating the seat heater because they may experience minor burns even at low temperatures. Use extra caution for;

- Babies, small children, elderly persons, sick persons or handicapped persons
- Persons who have delicate skin
- Persons who are exhausted
- Persons who have taken alcohol or drugs which induce sleep (sleeping drug, cold remedy, etc.).

To prevent the seat from overheating, do not use the seat heater with a blanket, cushion, or other insulating objects which cover the seat.

NOTICE

- *Do not put unevenly weighted objects on the seat and do not stick sharp objects (needles, nails, etc.) into the seat.*
- *When cleaning the seats, do not use organic substances (paint thinner, benzine, alcohol, gasoline, etc.). They may damage the heater and seat surface.*
- *To prevent the battery from being discharged, turn the switches off when the engine is not running.*

SECTION 1 - 3

INSTRUMENTS AND CONTROLS

Gauges, meters and service reminder indicators

Fuel gauge	38
Engine coolant temperature gauge	38
Tachometer	39
Odometer and trip meter	40
Service reminder indicators and warning buzzers	40
Instrument panel light control	50

GAUGES, METERS AND SERVICE REMINDER INDICATORS

FUEL GAUGE

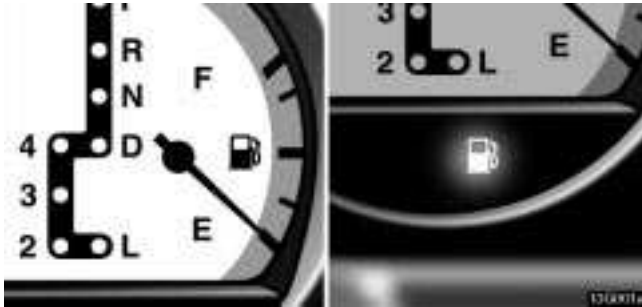

The gauge indicates the approximate quantity of fuel remaining in the tank when the ignition switch is on.

It is a good idea to keep the tank over 1/4 full.

If the fuel level approaches "E" or the low fuel level warning light comes on, fill the fuel tank as soon as possible.

On inclines or curves, due to the movement of fuel in the tank, the fuel gauge needle may fluctuate or the low fuel level warning light may come on earlier than usual.

If the fuel tank is completely empty, the malfunction indicator lamp comes on. Fill the fuel tank immediately.

The indicator lamp goes off after driving several times. If the indicator lamp does not go off, contact your Lexus dealer as soon as possible.

See the inner back cover for fuel capacity and recommended fuel selection.

ENGINE COOLANT TEMPERATURE GAUGE

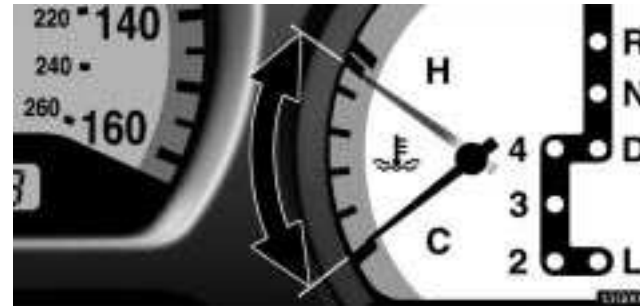

► **Normal range**

The gauge indicates the engine coolant temperature when the ignition switch is on. The engine operating temperature will vary with changes in weather and engine load.

If the needle points to the red zone or higher, stop your vehicle and allow the engine to cool.

Your vehicle may overheat during severe operating conditions, such as:

- Driving up a long hill on a hot day.
- Reducing speed or stopping after high speed driving.
- Idling for a long period with the air conditioning on in stop-and-go traffic.

GAUGES, METERS AND SERVICE REMINDER INDICATORS

NOTICE

- *Do not remove the thermostat in the engine cooling system as this may cause the engine to overheat. The thermostat is designed to control the flow of coolant to keep the temperature of the engine within the specified operating range.*
- *Do not continue driving with an overheated engine. See "If your vehicle overheats" on page 217.*

TACHOMETER



The tachometer indicates engine speed in thousands of rpm (revolutions per minute). Use it while driving to prevent engine over-revving.

Driving with the engine running too fast causes excessive engine wear and poor fuel economy. Remember, in most cases the slower the engine speed, the greater the fuel economy.

NOTICE

Do not let the indicator needle get into the red zone. This may cause severe engine damage.

GAUGES, METERS AND SERVICE REMINDER INDICATORS

ODOMETER AND TRIP METER



This meter displays the odometer and two trip meters. To change the mode indication, push the "ODO/TRIP" button.





The odometer records the total distance the vehicle has been driven. The twin trip meter records two different distances independently.

For example, you can use one meter to calculate the fuel economy and the other to measure the distance on each trip.







To change the trip meter indication from one trip to the other, push the "ODO/TRIP" button. To set the A trip meter to zero, display the A meter reading, then push the "RESET" button. The same applies for the B trip meter.



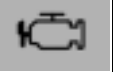

The data of trip meters will be cancelled if the electrical power source is disconnected.

SERVICE REMINDER INDICATORS AND WARNING BUZZERS



	IF THIS INDICATOR OR BUZZER COMES ON ...	DO THIS.
(a)	 or  (Indicator and buzzer)	If parking brake is off, stop immediately and contact Lexus dealer.
(b)	 (Indicator and buzzer)	Fasten driver's seat belt.
(c)	 (Indicator and buzzer)	Fasten front passenger's seat belt.
(d)		Take vehicle to Lexus dealer immediately.

GAUGES, METERS AND SERVICE REMINDER INDICATORS

IF THIS INDICATOR OR BUZZER COMES ON ...		DO THIS.
(e)		Stop and check.
(f)		Stop and check.
(g)		Add engine oil.
(h)	 or 	Take vehicle to Lexus dealer.
(i)	 or 	Take vehicle to Lexus dealer. If brake system warning light is also on, stop immediately and contact Lexus dealer.

IF THIS INDICATOR OR BUZZER COMES ON ...		DO THIS.
(j)		Close all doors.
(k)		Replace bulb.
(l)		Add washer fluid.
(m)		Fill up tank.
(n)		Take vehicle to Lexus dealer.

GAUGES, METERS AND SERVICE REMINDER INDICATORS

IF THIS INDICATOR OR BUZZER COMES ON ...		DO THIS.
(o)	 and 	Take vehicle to Lexus dealer.
(p)	Key reminder buzzer	Remove key.

(a) Brake System Warning Light and Buzzer

This light comes on in the following cases when the ignition key is in the "ON" position.

- **When the parking brake is applied ...**

This light comes on for a few seconds when the ignition key is turned to the "ON" position even after the parking brake is released.

If you drive your vehicle without releasing the parking brake, the buzzer sounds.

- **When the brake fluid level is low ...**



It is dangerous to continue driving normally when the brake fluid level is low.

- **When the hydraulic brake booster fails ...**

If the hydraulic booster causes a problem resulting in poor braking performance, the warning light comes on and buzzer sounds continuously.

Have your vehicle checked at your Lexus dealer in the following cases:

- The light does not come on even if the parking brake is applied when the ignition key is turned to the "ON" position.
- The light does not come on even if the ignition key is turned on with the parking brake released.

A warning light turned on briefly during operation does not indicate a problem.

GAUGES, METERS AND SERVICE REMINDER INDICATORS

CAUTION

If either of the following conditions occurs, immediately stop your vehicle at a safe place and contact your Lexus dealer.

- The light does not turn off even after the parking brake is released while the engine is running.
- The warning buzzer comes on together with the warning light.

In either case, this can indicate that the brakes may not work properly and your stopping distance will become longer. Depress the brake pedal firmly and bring the vehicle to an immediate stop.

Any of the following conditions may occur, but do not indicate the malfunction:

- The light may stay on for about 60 seconds after the ignition key is turned to the "ON" position. It is normal if it turns off after a while.
- Depressing the brake pedal repeatedly may turn on the warning light and buzzer. It is normal if the light turns off and the buzzer stops sounding after a few seconds.
- You may hear a small sound in the engine compartment after the engine is started or the brake pedal is depressed repeatedly. This is a pump pulsating sound of the brake system, and it is not a malfunction.

(b) Driver's Seat Belt Reminder Light and Buzzer

This light and buzzer remind you to buckle up the driver's seat belt.

Once the ignition key is turned to "ON" or "START", the reminder light flashes and buzzer sounds if the driver's seat belt is not fastened. Unless the driver fastens the belt, the light stays flashing and the buzzer stops after about 4 to 8 seconds.

(c) Front Passenger's Seat Belt Reminder Light

This light reminds you to buckle up the front passenger's seat belt.

Once the ignition key is turned to "ON" or "START", the reminder light flashes if a passenger sits in the front passenger seat and does not fasten the seat belt. Unless the front passenger fastens the belt, the light stays flashing. However, if a front passenger uses an additional seat cushion, the light may not flash even when the seat belt is not buckled up.

If luggage or other load is placed on the front passenger seat, depending on its weight and how it is placed on the seat, built-in sensors in the seat cushion may detect the pressure, causing the reminder light to come on.

GAUGES, METERS AND SERVICE REMINDER INDICATORS

(d) SRS Warning Light

The indicator comes on when the ignition key is turned to the "ON" position. It goes off after about 6 seconds. This means the SRS airbags and seat belt pretensioners are operating properly.

The SRS warning light system monitors the airbag sensor assembly, front airbag sensors, side and curtain shield airbag sensors, occupant detection sensor, seat belt buckle switch, front seat belt pretensioner assemblies, inflators, warning light, interconnecting wiring and power sources.

If either of the following conditions occurs, this indicates a malfunction somewhere in the parts monitored by the warning light system. Contact your Lexus dealer as soon as possible to service the vehicle.

- When the ignition key is turned to the "ON" position, the light does not come on, remains on or flashes.
- The light comes on or starts flashing while driving.

If the light stays on, it indicates that the driver and front passenger airbags have a problem. If the light flashes, the side and curtain shield airbags and/or seat belt pretensioners have a problem.

(e) Discharge Warning Light

This light warns that the battery is being discharged.

If it comes on while you are driving, stop the vehicle, turn off the engine, and check for the cause. Look first at the engine drive belt.

- If it is loose or broken, the generator will not charge the battery properly.
- If the belt is O.K., there is a problem somewhere in the charging system.

The engine ignition will continue to operate, however, until the battery is discharged. Turn off the air conditioning, blower, radio, etc., and drive directly to the nearest Lexus dealer or repair shop.

NOTICE

Do not continue driving if the engine drive belt is broken or loose.

GAUGES, METERS AND SERVICE REMINDER INDICATORS

(f) Low Engine Oil Pressure Warning Light

This light warns that the engine oil pressure is too low.

If it flickers or stays on while you are driving, pull off the road to a safe place and stop the engine immediately. Call a Lexus dealer or qualified repair shop for assistance.

The light may occasionally flicker when the engine is idling or it may come on briefly after a hard stop. There is no cause for concern if it then goes out when the engine is accelerated slightly.

The light may come on when the oil level is extremely low. It is not designed to indicate low oil level, and the oil level must be checked using the oil level dipstick.

NOTICE

Do not drive the vehicle with the warning light on – even for one block. It may ruin the engine.

(g) Low Engine Oil Level Warning Light

This light warns that the engine oil level is too low. Add oil as soon as possible. (For instructions, see "Checking the engine oil level" on page 260.)

While driving on steep inclines or rough roads which causes the vehicle to substantially sway or on curves, this light may come on due to the movement of engine oil in the engine.

In normal conditions, due to engine oil consumption, this light may come on earlier than the specified service interval of the scheduled maintenance. This is because the engine oil is consumed to the low level within the scheduled maintenance interval and does not indicate a problem. (For detailed information, see "Facts about engine oil consumption" on page 258.)

NOTICE

Continued engine operation with low engine oil will damage the engine.

GAUGES, METERS AND SERVICE REMINDER INDICATORS

(h) Malfunction Indicator Lamp

This lamp comes on when the ignition key is turned to the “ON” position and goes off after the engine starts. This means that the warning light system is operating properly.

If the lamp remains on, or the lamp comes on while driving, first check the followings:

- Empty fuel tank
If the fuel tank is empty, refuel immediately.
- Loose fuel tank cap
If the fuel tank cap is loose, securely tighten it.

These cases are temporary malfunctions. The malfunction indicator lamp will go off after taking several driving trips.

If the lamp will not go off even after several trips, contact your Lexus dealer as soon as possible.

If the fuel tank is not empty or the fuel tank cap is not loose...

- There is a problem somewhere in the engine, emission control system, electronic throttle control system, automatic transmission electrical system or warning light system itself.

Contact your Lexus dealer as soon as possible to service the vehicle.

GS430

If this lamp comes on and the engine speed does not increase with the accelerator pedal depressed, there may be a problem somewhere in your electronic throttle control system.

At this time, vibration may occur. However, if you depress the accelerator pedal more firmly and slowly, you can drive your vehicle at low speeds. Have your Lexus checked by your Lexus dealer as soon as possible.

Even if the abnormality of the electronic throttle control system is corrected during low speed driving, the system may not be recovered until the engine is stopped and the ignition key is turned to “ACC” or “LOCK” position.

GS300

If this lamp comes on and the engine speed does not increase with the accelerator pedal depressed down to about the middle position, there may be a problem somewhere in your electronic throttle control system.

At this time, if you depress the accelerator pedal more firmly and slowly, you can drive your vehicle at low speeds. Have your Lexus checked by your Lexus dealer as soon as possible.

Even if the abnormality of the electronic throttle control system is corrected during low speed driving, the system may not be recovered until the engine is stopped and the ignition key is turned to “ACC” or “LOCK” position.

GAUGES, METERS AND SERVICE REMINDER INDICATORS

Emissions inspection and maintenance (I/M) programs

Your vehicle may not pass a state emission inspection if the malfunction indicator lamp remains on. Contact your Lexus dealer to check your vehicle's emission control system and OBD (On-Board Diagnostics) system before taking your vehicle for the inspection.

For details, see "Emissions inspection and maintenance (I/M) programs" on page 239.

(i) "ABS" Warning Light

The light comes on when the ignition key is turned to the "ON" position. If the anti-lock brake system and the brake assist system work properly, the light turns off after a few seconds. Thereafter, if either of the systems malfunctions, the light comes on again.

When the "ABS" warning light is on (and the brake system warning light is off), the anti-lock brake system, the brake assist system, the traction control system and/or the vehicle stability control system do/does not operate, but the brake system still operates conventionally.

When the "ABS" warning light is on (and the brake system warning light is off), the anti-lock brake system does not operate so that the wheels could lock up during a sudden braking or braking on slippery road surfaces.

If either of the following conditions occurs, this indicates a malfunction somewhere in the parts monitored by the warning light system. Contact your Lexus dealer as soon as possible to service the vehicle.

- The light does not come on when the ignition key is turned to the "ON" position, or remains on.
- The light comes on while you are driving.

GAUGES, METERS AND SERVICE REMINDER INDICATORS

A warning light turning on briefly during operation does not indicate a problem.

Either of the following conditions may occur, but do not indicate the malfunction:

- The light may stay on for about 60 seconds after the ignition key is turned to the "ON" position. It is normal if it turns off after a while.
- Depressing the brake pedal repeatedly may turn on the light. It is normal if it turns off after a few seconds.

(j) Open Door Warning Light

This light remains on until all the doors are completely closed.

(k) Rear Light Failure Warning Light

If this light comes on when the headlight switch is turned on (at the first or second clickstop), it indicates that one or more of the tail lights are burned out.

If it comes on when the brake pedal is depressed, one or more stop lights are burned out.

Have defective bulbs replaced as soon as possible.

(l) Low Washer Fluid Warning Light

This light comes on when the fluid level in the tank becomes very low. Fill the tank as soon as possible.

(m) Low Fuel Level Warning Light

This light comes on when the fuel level in the tank becomes very low. Fill the tank as soon as possible.

On inclines or curves, due to the movement of fuel in the tank, the low fuel level warning light may come on earlier than usual.

(n) Automatic Headlight Leveling System Warning Light

This light warns that there is a problem somewhere in the automatic headlight leveling system.

If it comes on, have your vehicle checked by your Lexus dealer.

GAUGES, METERS AND SERVICE REMINDER INDICATORS

(o) Vehicle Stability Control System Warning Lights

These lights warn that there is a problem somewhere in the vehicle stability control system or traction control system.

If the "VSC" warning light and "VSC OFF" indicator light come on, have your vehicle checked by Lexus dealer as soon as possible.

The lights will come on when the ignition key is turned to "ON", and will go off after about a few seconds.

The lights may stay on for 60 seconds after the ignition key is turned to the "ON" position. It is normal if they go out after a while.

Depressing the brake pedal repeatedly may turn on the lights. It is normal if they go out after a few seconds.

If the "VSC" warning light and "VSC OFF" indicator light come on, the vehicle stability control system does not activate, however, it is no problem to continue your driving.

(p) Key Reminder Buzzer

This buzzer reminds you to remove the key when you open the driver's door with the ignition key in the "ACC" or "LOCK" position.

How to check all the service reminder indicators

(except the low fuel level warning light):

1. Apply the parking brake.
2. Open the door.

The following service reminder indicator should come on. It goes off when you close the door completely.



3. Turn the ignition key to "ON".

The following service reminder indicators should come on.

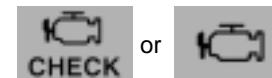

GAUGES, METERS AND SERVICE REMINDER INDICATORS

The following service reminder indicators go off after a few seconds.



The following service reminder indicator goes off after about 6 seconds.



The lights other than the slip indicator light may stay on for about 60 seconds after the ignition key is turned to the "ON" position. It is normal if they go out after a while.

If any service reminder indicator or warning buzzer does not function as described above, have it checked by your Lexus dealer as soon as possible.

INSTRUMENT PANEL LIGHT CONTROL



The brightness of the instrument panel lights is automatically adjusted depending on the brightness of your surroundings. To adjust the brightness as you like, turn the knob. However, if the brightness is automatically adjusted at the maximum, turning the knob cannot change the brightness.

When the headlight switch is in the first or second click stop, you can also adjust the brightness of the displays on the audio and air conditioning systems using this knob.

SECTION 1 - 4

INSTRUMENTS AND CONTROLS

Interior equipment

Vanity mirrors	52
Interior lights	53
Personal lights	53
Ignition switch light	54
Clock	54
Cigarette lighter and ashtray	55
Power outlet	56
Rear console box	57
Glove box	57
Garage door opener	58
Cup holders	61
Coin box	62
Tie-down hooks	62
Floor mat	63
First-aid kit holder	64
Luggage stowage precautions	64

INTERIOR EQUIPMENT

VANITY MIRRORS



To use the vanity mirrors, swing the sun visor down and open the cover.

The vanity light comes on when you open the cover.

Sun visors

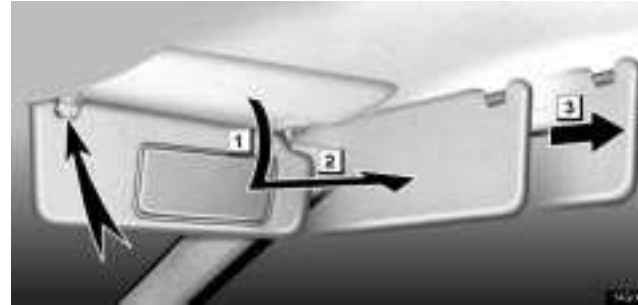

- 1** To block out glare from the front, swing the sun visor down.
- 2** To block out glare from the side, remove the sun visor from the hook and swing it to the side.
- 3** To block out glare coming obliquely from behind you, slide the visor backwards.

At this position, the vanity light does not come on.

INTERIOR LIGHTS



To turn on the interior light, slide the switch.

With the switch in the "DOOR" position, the light comes on when any door is opened. After all the doors are closed, the light remains on for about 15 seconds and then goes out.

However, in the following cases, the light goes out immediately:

1. All the doors are closed when the ignition key is in "ACC" or "ON" position.
2. The ignition key is turned to "ACC" or "ON" when the light is still on.
3. All the doors are locked when the light is still on.
4. One door is closed with the lock button pushed in while the other doors are locked.

PERSONAL LIGHTS

Front



Rear



To turn on the personal light, push the switch. To turn it off, push the switch again.

INTERIOR EQUIPMENT

IGNITION SWITCH LIGHT



For easy access to the ignition switch, the ignition switch light comes on when any of the doors are opened.

The light remains on for about 15 seconds and goes out after all the doors are closed. However, the light goes out immediately when all the doors are locked or the ignition key is in the "ACC" or "ON" position.

CLOCK



The digital clock indicates the time with the ignition key at the "ACC" or "ON" position. To reset the hour, press the "H" button. To reset the minutes, press the "M" button. To adjust the time to the nearest hour, press the ":00" button.

For example, if the ":00" button is pressed when the time is between 9:30 – 9:59 or between 10:01 – 10:29, the time will change to 10:00.

With the tail lights on, the background brightness of the time indication will be reduced.

If the electrical power source has been disconnected from the clock, the time display will automatically be set to 1:00 (one o'clock).

CIGARETTE LIGHTER AND ASHTRAY

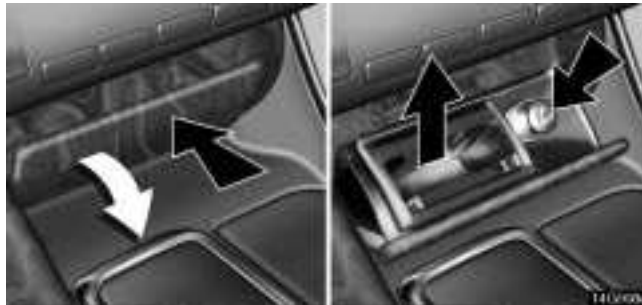

► Front cigarette lighter and ashtray

To use the cigarette lighter and ashtray, first push against the ashtray cover. Then when the ashtray opens out, press in the cigarette lighter. After it finishes heating up, it automatically pops out ready for use.

Do not hold the cigarette lighter pressed in.

If the engine is not running, the ignition key must be in the "ACC" position to use the lighter.

When finished with your cigarette, thoroughly extinguish it in the ashtray to prevent other cigarette butts from catching fire. After using the ashtray, push it back in completely.

To remove the ashtray, just pull it up.

Use a Lexus genuine cigarette lighter or equivalent for replacement.



► Rear ashtray

To use the ashtray, pull on the lid.

When finished with your cigarette, thoroughly extinguish it in the ashtray to prevent other cigarette butts from catching fire. After using the ashtray, push it back in or close the lid completely.

To remove the ashtray, just pull it up.



CAUTION

To reduce the chance of injury in case of an accident or sudden stop while driving, always close the ashtray completely after use.

INTERIOR EQUIPMENT

POWER OUTLET

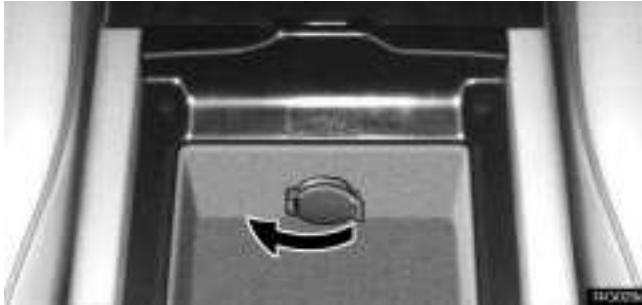

The power outlet is designed for power supply for car accessories.

The ignition key must be in the "ACC" or "ON" position for the power outlet to be used.

NOTICE

- *To prevent the fuse from being blown, do not use the electricity over the total vehicle capacity of 12V 3.5A.*
- *To prevent the battery from being discharged, do not use the power outlet longer than necessary when the engine is not running.*

- *Close the power outlet lid when the power outlet is not in use. Inserting a foreign object other than the appropriate plug that fits the outlet, or allowing any liquid into the outlet may cause electrical failure or short circuits.*

REAR CONSOLE BOX

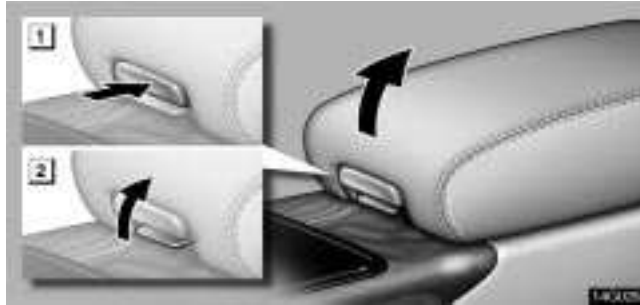

- **1** For upper box **2** For lower box

To use the rear console box, open as shown in the illustration.

GLOVE BOX

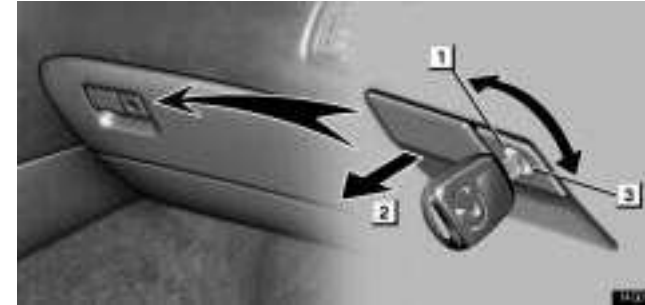

- **1** Unlock **2** Open **3** Lock

To open the glove box door, pull the lever. To lock the glove box door, insert the master key and turn it clockwise.

With the tail lights on, the glove box light will come on when the glove box door is open.

! CAUTION

To reduce the chance of injury in case of an accident or a sudden stop, always keep the glove box door closed while driving.

INTERIOR EQUIPMENT

GARAGE DOOR OPENER

The garage door opener (**HomeLink® Universal Transceiver**) is manufactured under license from HomeLink® and can be programmed to operate garage doors, gates, entry doors, door locks, home lighting systems, and security systems, etc.

(a) Programming the HomeLink®

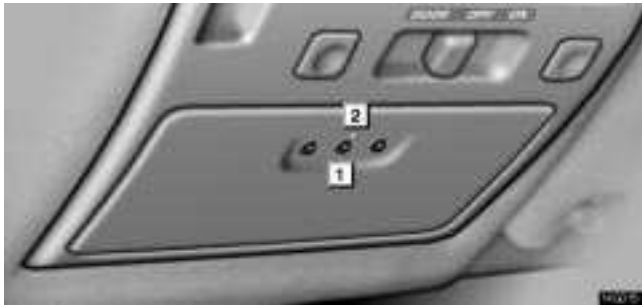

► **1 Buttons** **2 Indicator light**

The HomeLink® in your vehicle has 3 buttons and you can store one program for each button.

To ensure correct programming into the HomeLink®, install a new battery in the hand-held transmitter prior to programming.

The battery side of the hand-held transmitter must be pointed away from the HomeLink® during the programming process.

For Canadian users, follow the procedure in “Programming an entrance gate/Programming all devices in the Canadian market”.

1. Decide which of 3 HomeLink® buttons you want to program.
2. Place your hand-held garage transmitter 25 to 75 mm (1 to 3 in.) away from the surface of the HomeLink®.

Keep the indicator light on the HomeLink® in view while programming.

3. Simultaneously press and hold the hand-held garage transmitter button along with the selected HomeLink® button.
4. When the indicator light on the HomeLink® changes from a slow to a rapid flash after 20 seconds, you can release both buttons.

5. Test the operation of the HomeLink® by pressing the newly programmed button. If programming a garage door opener, check to see if the garage door opens and closes.

If the garage door does not operate, identify if your garage transmitter is of the “Rolling Code” type. Press and hold the programmed HomeLink® button. The garage door has the rolling code feature if the indicator light (on the HomeLink®) flashes rapidly and then remains lit after 2 seconds. If your garage transmitter is the “Rolling Code” type, proceed to the heading “Programming a rolling code system”.

6. Repeat steps 2 through 5 for each remaining HomeLink® button to program another device.

Programming a rolling code system

If your device is “Rolling Code” equipped, it is necessary to follow steps 1 through 4 under the heading “Programming the HomeLink®” before proceeding with the steps listed below.

1. Locate the “training” button on the ceiling mounted garage door opener motor. The exact location and color of the button may vary by brand of garage door opener. Refer to the owner’s guide supplied by the garage door opener manufacturer for the location of this “training” button.

2. Press the “training” button on the ceiling mounted garage door opener motor.

Following this step, you have 30 seconds in which to initiate step 3 below.

3. Press and release the vehicle’s programmed HomeLink® button twice. The garage door may open. If the door does not open, the programming process is complete. If the door does not open, press and release the button a third time. This third press and release will complete the programming process by opening the garage door.

The ceiling mounted garage door opener motor should now recognize the HomeLink® unit and be able to activate the garage door up/down.

4. Repeat steps 1 through 3 for each remaining HomeLink® button to program another rolling code system.

Programming an entrance gate / Programming all devices in the Canadian market

1. Decide which of the 3 HomeLink® buttons you want to program.

2. Place your hand-held gate/device transmitter 25 to 75 mm (1 to 3 in.) away from the surface of the HomeLink®.

Keep the indicator light on the HomeLink® in view while programming.

3. Press and hold the selected HomeLink® button.

4. Continuously press and release (cycle) the hand-held gate/device transmitter button every two seconds until step 5 is complete.

5. When the indicator light on the HomeLink® changes from a slow to a rapid flash after 20 seconds, you can release both buttons.

6. Test the operation of the HomeLink® by pressing the newly programmed button. Check to see if the gate/device operates correctly.

7. Repeat steps 1 through 6 for each remaining HomeLink® button to program another device.

Programming other devices

To program other devices such as home security systems, home door locks or lighting, contact your authorized Lexus dealer for assistance.

INTERIOR EQUIPMENT

Reprogramming a button

Individual HomeLink[®] buttons cannot be erased, however, to reprogram a single button, follow the procedure "Programming the HomeLink[®]".

(b) Operating the HomeLink[®]

To operate the HomeLink[®], press the appropriate HomeLink[®] button to activate the programmed device. The HomeLink[®] indicator light should come on. The HomeLink[®] continues to send the signal for up to 20 seconds as long as the button is pressed.

(c) Erasing the entire HomeLink[®] memory (all three programs)

To erase all previously programmed codes at one time, press and hold down the 2 outside buttons for 20 seconds until the indicator light flashes.

If you sell your vehicle, be sure to erase the programs stored in the HomeLink[®] memory.



CAUTION

- When programming the HomeLink[®] Universal Transceiver, you may be operating a garage door or other device. Make sure people and objects are out of the way of the garage door or other device to prevent potential harm or damage.

- Do not use this HomeLink[®] Universal Transceiver with any garage door opener that lacks the safety stop and reverse feature as required by federal safety standards. (This includes any garage door opener model manufactured before April 1, 1982.) A garage door opener which cannot detect an object (signaling the door to stop and reverse), does not meet current federal safety standards. Using a garage door opener without these features increases risk of serious injury or death.

FCC ID: CB2V94800
CANADA: 1763 102 264

This device complies with FCC Rules part 15. Operation is subject to the following two conditions: (1) This device may not cause harmful interference, and (2) this device must accept any interference that may be received, including interference that may cause undesired operation. **WARNING: This transmitter has been tested and complies with FCC and DOC/MDC rules. Changes or modifications not expressly approved by the party responsible for compliance could void the user's authority to operate the device.**

CUP HOLDERS



► **Front**

To use the cup holder, push the cup holder lid.

You can use it as an accessory box by removing the holder inside.

⚠ CAUTION

- Do not place anything else other than cups or drink-cans in the cup holder, as such items may be thrown about in the compartment and possibly injure people in the vehicle during sudden braking or in an accident.
- To reduce the chance of injury in case of an accident or sudden stop while driving, keep the cup holder closed when not in use.



► **Rear**

To use the cup holder, push the cup holder portion of the center armrest in the rear seat.

The cup holder is designed for holding cups or drink-cans securely.

⚠ CAUTION

- Do not place anything else other than cups or drink-cans in the cup holder, as such items may be thrown about in the compartment and possibly injure people in the vehicle during sudden braking or in an accident.
- To reduce the chance of injury in case of an accident or sudden stop while driving, keep the cup holder closed when not in use.

INTERIOR EQUIPMENT

COIN BOX (U.S.A. ONLY)



To use the coin box, push against the coin box cover.



CAUTION

Keep the coin box closed when not in use.

TIE-DOWN HOOKS



To secure your luggage, use the tie-down hooks as shown above.

See "Luggage stowage precautions" on page 64 for precautions in loading luggage.



CAUTION

To avoid personal injury, keep the tie-down hooks stored under the carpet when not in use.

FLOOR MAT

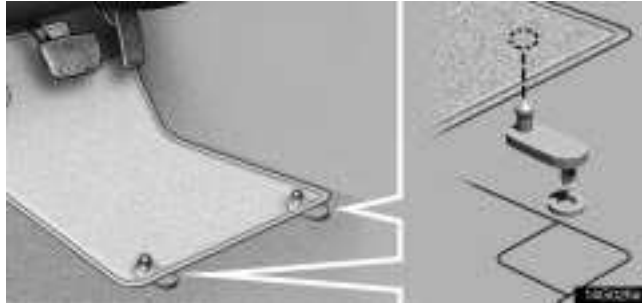

Use a floor mat of the correct size.

If the floor carpet and floor mat have 2 holes, then they are designed for use with locking clips. Fix the floor mat with locking clips into the holes in the floor carpet.



CAUTION

Make sure the floor mat is properly placed on the floor carpet. If the floor mat slips and interferes with the movement of the pedals during driving, it may cause an accident.

INTERIOR EQUIPMENT

FIRST-AID KIT HOLDER

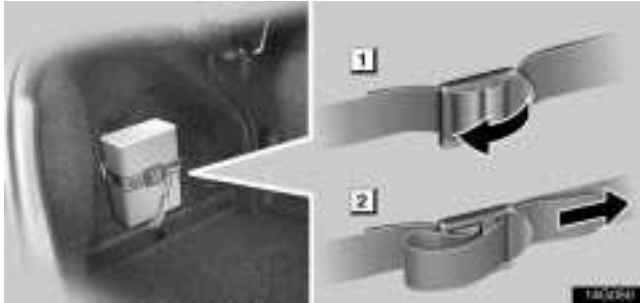

► **1 To loosen** **2 To tighten**

This belt is designed to hold the first-aid kit.

To loosen: Pull the buckle forward.

To tighten: Pull on the belt.

Make sure the first-aid kit is securely held.

LUGGAGE STOWAGE PRECAUTIONS

When stowing luggage or cargo in the vehicle, observe the following:

- Put luggage or cargo in the trunk when at all possible. Be sure all items are secured in place.
- Be careful to keep the vehicle level. Placing the weight as far forward as possible helps maintain vehicle balance.
- For better fuel economy, do not carry unnecessary weight.

CAUTION

- **Do not place anything on the package tray behind the rear seatback. Such items may be thrown about and possibly injure people in the vehicle during sudden braking or in an accident.**
- **Do not drive with objects left on top of the instrument panel. They may interfere with the driver's field of view. Or they may move during sharp vehicle acceleration or turning, and impair the driver's control of the vehicle. In an accident they may injure the vehicle occupants.**

NOTICE

Do not load the vehicle beyond the vehicle capacity weight specified on the tire pressure label.

SECTION 1 - 5

INSTRUMENTS AND CONTROLS

Exterior equipment

Hood	66
Trunk lid	67
Fuel tank cap	69
Moon roof	70

EXTERIOR EQUIPMENT

HOOD



1. To open the hood, pull the hood lock release lever under the instrument panel. The hood will spring up slightly.



2. Insert your fingers under the hood, push up the auxiliary catch lever and lift the hood.

Before closing the hood, check to see that you have not forgotten any tools, rags, etc. Then lower the hood and make sure it locks.

CAUTION

Before driving, be sure that the hood is closed and securely locked. Otherwise, the hood may open unexpectedly while driving and an accident may occur.

TRUNK LID



To unlock the trunk lid, insert the master key and turn it clockwise.

To close the trunk lid, lower it and press down on it. After closing the trunk lid, try pulling it up to make sure it is securely closed.

The trunk lid can be unlocked using the wireless remote control key. For details, see page 15.

CAUTION

- Keep the trunk lid closed while driving. This not only keeps the luggage from being thrown out, but also prevents exhaust gases from entering the vehicle.
- Always lock the trunk lid and all doors, and keep away the vehicle keys out of children's reach.

- Never leave children unattended in the vehicle. Un supervised children may lock themselves in the vehicles or trunk and suffer serious injuries or death.

Trunk lid opener



► **1** Main switch **2** Operative **3** Inoperative

To open the trunk lid while sitting in the driver's seat, pull the lever with the main switch not pushed in.

EXTERIOR EQUIPMENT

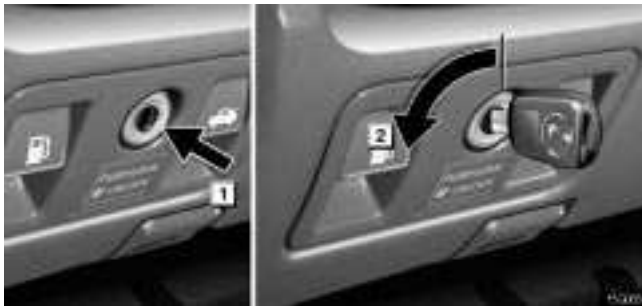

- 1** If you do not want to activate the trunk lid opener system, push in the main switch.
- 2** To activate the system, insert the master key and turn it counterclockwise.

To protect things put in the trunk, when you have your vehicle parked, push in the main switch.

Internal trunk release handle



If a person is locked in the trunk, he/she can pull down the phosphorescent handle on the inside of trunk lid to open the trunk lid.

The phosphorescent (glow-in-the-dark) handle will continue to glow for a time after the trunk lid is closed. Exposing the handle to stronger light will cause it to glow longer.

FUEL TANK CAP



1. To open the fuel filler door, pull the lever under the instrument panel.

When refueling, turn off the engine.

CAUTION

- Do not smoke, cause sparks or allow open flames when refuelling. The fumes are flammable.
- When opening the cap, do not remove the cap quickly. In hot weather, fuel under pressure could cause injury by spraying out of the filler neck if the cap is suddenly removed.

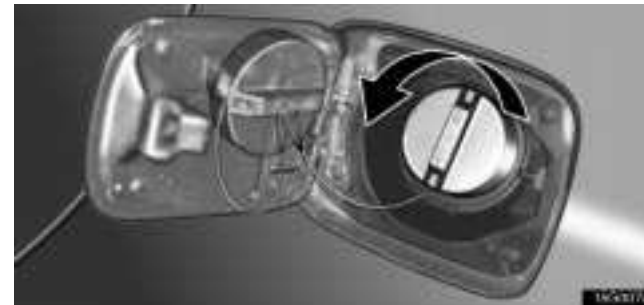

2. To remove the fuel tank cap, turn the cap slowly counterclockwise, then pause slightly before removing it. The removed cap can be stored on the back side of the fuel filler door.

It is not unusual to hear a slight swoosh when the cap is opened. When installing the cap, turn the cap clockwise until you hear a click.

If the cap is not installed securely, the malfunction indicator lamp comes on. Make sure the cap is installed securely.

The indicator lamp goes off after driving several times. If the indicator lamp does not go off, contact your Lexus dealer as soon as possible.

EXTERIOR EQUIPMENT

CAUTION

- Make sure the cap is installed securely to prevent fuel spillage in the event of an accident.
- Use only a genuine Lexus fuel tank cap for replacement. It is designed to regulate fuel tank pressure.

In case the opener is not actuated

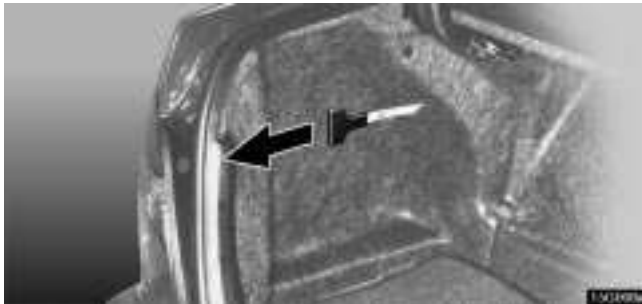

Pull the manual lever toward the back.

This is used in case the fuel filler door cannot be opened due to a discharged battery or other trouble.

MOON ROOF



► **1** Open **2** Close

To slide open the moon roof, push the switch toward the back. The moon roof will fully open. To stop partway, push the same switch or "TILT" switch.

The sun shade can be opened or closed manually. However, if you open the moon roof, the sun shade will be opened with the moon roof.

To close the moon roof, push the switch toward the front. The moon roof will fully close. To stop partway, push the same switch or "TILT" switch.



► **1** Tilt up **2** Lower

To tilt up the rear end of the moon roof fully, push the switch on the rear side or on the front side to lower it.

To operate the moon roof, the ignition key must be in the "ON" position.

Key off operation: Even if the ignition key is turned to the "ACC" or "LOCK" position, the moon roof can be operated until any of the doors is opened (or for about 45 seconds).

Operating the moon roof from outside the vehicle

The moon roof can be closed or opened using an ignition key.*

Insert the ignition key into the key hole on the driver's door.

To close the moon roof: Turn the key in the locking direction and hold it.

After the door is locked, the moon roof begins to close. To stop in the middle, return the key.

To open the moon roof: Turn the key in the unlocking direction and hold it.

After the door is unlocked, the moon roof begins to open. To stop in the middle, return the key.

*NOTE: *This feature can be set inoperative, or sliding open or tilting up can be selected. Ask your Lexus dealer for details.*

EXTERIOR EQUIPMENT

Jam protection function

If something gets caught into the roof opening during closing operation, the moon roof stops and is open.

If the moon roof receives a strong impact, this function may work even if nothing is caught.



CAUTION

To avoid serious personal injury, you must do the following.

- While the vehicle is moving, always keep the heads, hands and other parts of the bodies of all occupants away from the roof opening. Otherwise, they could be seriously injured if the vehicle stops suddenly or if the vehicle is involved in an accident.
- Before you close the moon roof, always make sure there is nobody around the moon roof. You must also make sure nobody places his or her head, hands and other parts of the body in the roof opening. If someone's neck, head or hands get caught in the closing roof, it could result in a serious injury. When anyone closes the moon roof, first make sure it is safe to do so.
- Be sure to remove the ignition key or turn the ignition switch to the "LOCK" position when you leave your vehicle.

- Never leave anyone (particularly a small child) alone in your vehicle, especially with the ignition key still inserted or with the ignition switch in a position other than "LOCK". Otherwise, he/she could use the moon roof switches and get trapped in the roof opening. Unattended person (particularly a small child) can be involved in a serious accident.
- Never sit on top of the vehicle around the roof opening.
- Never try jamming any part of your body to activate the jam protection function intentionally.
- The jam protection function may not work if something gets caught just before the moon roof fully closed.

SECTION 1 – 6

INSTRUMENTS AND CONTROLS

Comfort adjustment

Seats	74
Head restraints	79
Tilt and telescopic steering wheel	80
Outside rear view mirrors	82
Inside rear view mirror	83
Seat belts	88
SRS airbags	97
Child restraint	111
Driving position memory system	130

COMFORT ADJUSTMENT

SEATS

While the vehicle is being driven, all vehicle occupants should have the seatback upright, sit well back in the seat and properly wear the seat belts provided.

CAUTION

- Do not drive the vehicle unless the occupants are properly seated. Do not allow passengers to sit in the luggage compartment or cargo area. Persons not properly seated and/or properly restrained by seat belts can be severely injured in the event of emergency braking or a collision.
- During driving, do not allow passengers to stand up or move around between seats. Otherwise, severe injuries can occur in the event of emergency braking or a collision.

Front seat precautions

Driver seat

CAUTION

The driver airbag deploys with considerable force, and can cause death or serious injury especially if the driver is very close to the airbag. The National Highway Traffic Safety Administration ("NHTSA") advises:

Since the risk zone for driver airbag is the first 50–75 mm (2–3 in.) of inflation, placing yourself 250 mm (10 in.) from your driver airbag provides you with a clear margin of safety. This distance is measured from the center of the steering wheel to your breastbone. If you sit less than 250 mm (10 in.) away now, you can change your driving position in several ways:

- Move your seat to the rear as far as you can while still reaching the pedals comfortably.
- Slightly recline the back of the seat. Although vehicle designs vary, many drivers can achieve the 250 mm (10 in.) distance, even with the driver seat all the way forward, simply by reclining the back of the seat somewhat. If reclining the back of your seat makes it hard to see the road, raise yourself by using a firm, non-slippery cushion, or raise the seat if your vehicle has that feature.

- If your steering wheel is adjustable, tilt it downward. This points the airbag toward your chest instead of your head and neck.

The seat should be adjusted as recommended by NHTSA above, while still maintaining control of the foot pedals, steering wheel, and your view of the instrument panel controls.

Front passenger seat

 **CAUTION**

The front passenger airbag also deploys with considerable force, and can cause death or serious injury especially if the front passenger is very close to the airbag. The front passenger seat should be as far from the airbag as possible with the seatback adjusted, so the front passenger sits upright.

Front seats

 **CAUTION**

The side airbags are installed in the driver and front passenger seats. Observe the following precautions.

- Do not lean against the front door when the vehicle is in use, since the side airbag inflates with considerable speed and force. Otherwise, you may be killed or severely injured.
- Do not use seat accessories which cover the parts where the side airbags inflate. Such accessories may prevent the side airbags from activating correctly, causing death or serious injury.
- Do not modify or replace the seats or upholstery of front seats equipped with side airbags. Such changes may prevent the side airbags from activating correctly, disable the system, or cause the side airbags to inflate accidentally, resulting in death or serious injury.

COMFORT ADJUSTMENT

Seat adjustment precautions

CAUTION

- Do not adjust the seat while the vehicle is moving as the seat may unexpectedly move and cause the driver to lose control of the vehicle.
- Be careful that the seat does not hit a passenger, luggage, or the rear seat.

NOTICE

Do not operate the control switch in more than one dimension at a time. It may cause electrical overload.

Adjusting front seats



- ▶ **1** Seat position control switch, seat cushion angle and height control switch
- 2** Seatback angle control switch
- 3** Lumbar support control switch

Adjusting seat position



Move the control switch in the desired direction.

Releasing the switch will stop the seat in that position. Do not place anything under the seat, as this might interfere with the seat movement.

Adjusting seatback angle



Move the control switch in the desired direction.

Releasing the switch will stop the seatback in that position.



CAUTION

To reduce the risk of sliding under the lap belt during a collision, avoid reclining the seatback any more than needed. The seat belts provide maximum protection in a frontal or rear collision when the driver and the passenger are sitting up straight and well back in the seats. If you are reclined, the lap belt may slide past your hips and apply restraint forces directly to the abdomen. In the event of a frontal collision, the more the seat is reclined, the greater the risk of personal injury.

COMFORT ADJUSTMENT

Adjusting seat cushion angle and height



Move the control switch in the desired direction.
Releasing the switch will stop the seat cushion in that position.

Adjusting lumbar support



Push the control switch on either side.
The amount of lumbar support will change while the switch is pushed.

HEAD RESTRAINTS

Front seats

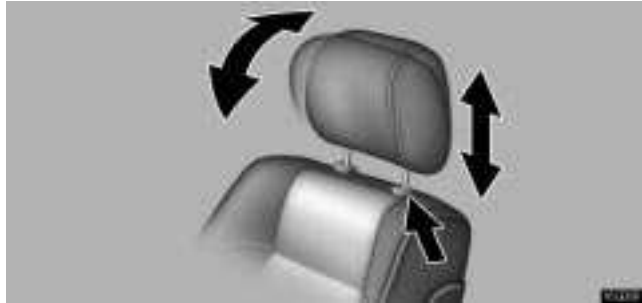

To raise the head restraint, pull it up. To lower it, press the lock release button and push the head restraint down. To move the head restraint forward or rearward, pull or push on the top.

The head restraint is most effective when it is close to your head. Therefore, using a cushion on the seatback is not recommended.

CAUTION

- Adjust the center of the head restraint so that it is closest to the top of your ears.
- After adjusting the head restraint, make sure it is locked in position.
- Do not drive with the head restraints removed.

Rear seats

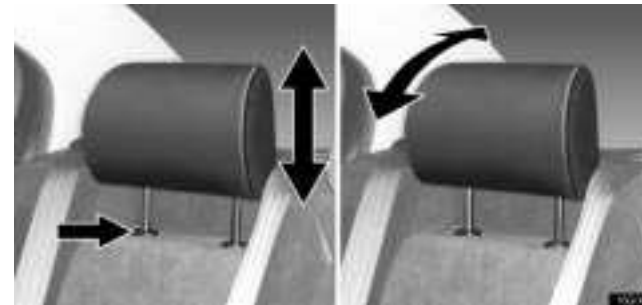

► *Outside rear seats*

To raise the head restraint, pull it up. To lower it, press the lock release button and push the head restraint down. To move the head restraint forward or rearward, pull or push on the top.

COMFORT ADJUSTMENT

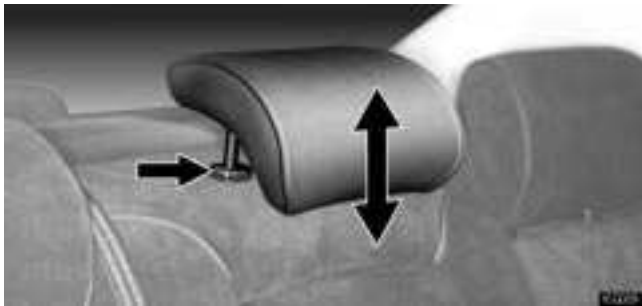

► Center rear seat

To raise the head restraint, pull it up. To lower it, press the lock release button and push the head restraint down.

Center rear head restraint: When an occupant sits on the center rear seat, always pull up the head restraint to the lock position.

The head restraint is most effective when it is close to your head. Therefore, using a cushion on the seatback is not recommended.

CAUTION

- Adjust the center of the head restraint so that it is closest to the top of your ears.
- After adjusting the head restraint, make sure it is locked in position.
- Do not drive with the head restraints removed.

TILT AND TELESCOPIC STEERING WHEEL

Adjustment of steering wheel tilt



To adjust the tilt of the steering wheel, push the control switch upward or downward to set it to the desired position.

CAUTION

Do not adjust the steering wheel while the vehicle is moving. Doing so may cause the driver to mishandle the vehicle and an accident may occur resulting in death or serious injuries.

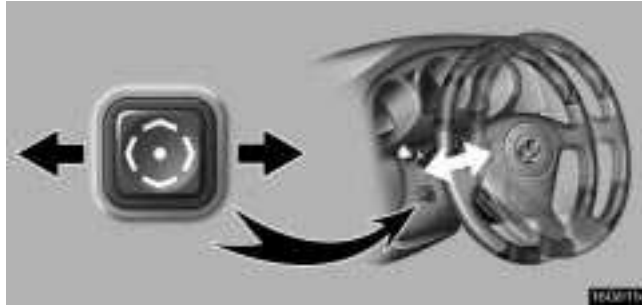
Adjustment of telescopic steering column

To adjust the steering column length, push the control switch forward or backward to set the steering wheel to the desired position.

CAUTION

Do not adjust the steering column while the vehicle is moving. Doing so may cause the driver to mishandle the vehicle and an accident may occur resulting in death or serious injuries.

Auto tilt away*

When the ignition key is removed, the steering column moves forward away from the driver and also tilts up for easy exit and entry.

When the key is inserted in the ignition switch, the steering column returns to the previously set position.

*NOTE: *This feature can be deactivated. Ask your Lexus dealer for details.*

COMFORT ADJUSTMENT

OUTSIDE REAR VIEW MIRRORS



Adjust the mirror so that you can just see the side of your vehicle in the mirror.

Be careful when judging the size or distance of any object seen in the outside rear view mirror on the passenger's side because it is a convex mirror. Any object seen in a convex mirror will look smaller and farther away than if seen in a normal flat mirror.

When the inside rear view mirror darkens in "AUTO" mode, the outside rear view mirrors also darken to reduce the reflection of the headlights of the following vehicle. For details, see "Inside rear view mirror" on page 83.

When you push the rear window defogger switch, the heater panels in the outside rear view mirrors will quickly clear the mirror surface. (See "Rear window and outside rear view mirror defogger switch" on page 31.)

CAUTION

- Do not adjust the mirror while the vehicle is moving. Doing so may cause the driver to mishandle the vehicle and an accident may occur resulting in death or serious injuries.
- Since the mirror surfaces can get hot, do not touch them when the rear window and outside rear view mirror defogger switch is on.

Power rear view mirror control



► **1** Master switch **2** Control switch

To adjust the power rear view mirror, first place the master switch at "L" (left) or "R" (right), and push the control switch on the desired side.

The power rear view mirrors can be adjusted when the key is in the "ACC" or "ON" position.

NOTICE

If ice should jam the mirror, do not operate the control or scrape the mirror face. Use a spray de-icer to free the mirror.

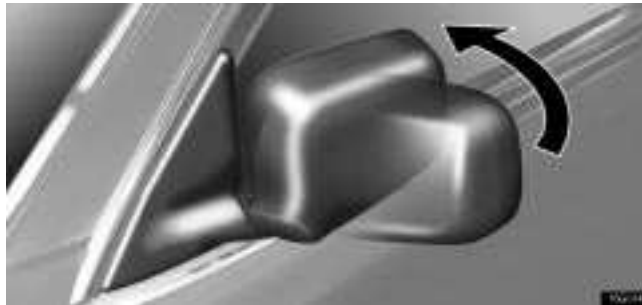
Folding rear view mirrors

To fold the rear view mirror, push backward.

The rear view mirrors can be folded backward for parking in compact areas.

CAUTION

Do not drive with the mirrors folded backward. Both the driver and passenger side rear view mirrors must be extended and properly adjusted before driving.

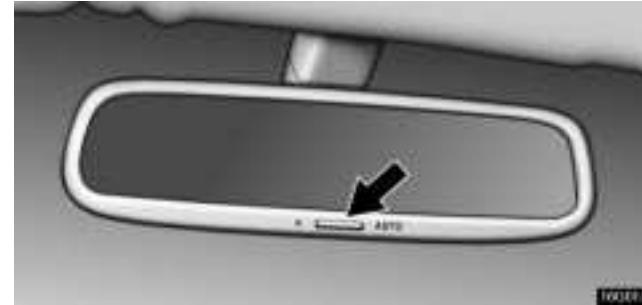
INSIDE REAR VIEW MIRROR

Adjust the mirror so that you can just see the rear of your vehicle in the mirror.

Pushing the switch changes the mode between "AUTO" and "DAY".

The indicator comes on when the "AUTO" mode is selected.

"DAY" mode: The mirror surface is normal.

"AUTO" mode: If the mirror detects light from the headlights of the vehicle behind you, the mirror surface darkens slightly to reduce the reflected light.

When the inside rear view mirror surface changes, the outside rear view mirror surfaces will also become darker.

When the ignition key is inserted and turned on, the inside rear view mirror always turns on in the "AUTO" mode.

COMFORT ADJUSTMENT

When the outside air temperature is low, it may take a little longer for the mirror to darken in response to the detection of headlights.

CAUTION

Do not adjust the mirror while the vehicle is moving. Doing so may cause the driver to mishandle the vehicle and an accident may occur resulting in death or serious injuries.



To ensure correct functioning of an anti-glare mirror sensor located on the back side of the mirror, do not touch or cover the sensor with your finger or a piece of cloth, etc.

Compass (Vehicles without Navigation System sold in U.S. mainland and Canada)



The compass indicates the direction in which the vehicle is heading. The illustration shown above indicates the vehicle is heading north.

Displays	Directions
N	North
NE	Northeast
E	East
SE	Southeast
S	South
SW	Southwest
W	West
NW	Northwest

Pushing the button for longer than 3 seconds turns on or off the compass display.

The compass may not show the correct direction in the following conditions:

- The vehicle is stopped immediately after turning.
The compass does not adjust while the vehicle is stopped.
- The ignition switch is turned off immediately after turning.
- The vehicle is on an inclined surface.
- The vehicle is in a place where the earth's magnetic field is subject to interference by artificial magnetic fields (underground parking, under a steel tower, between buildings, roof parking, near a crossing, near a large vehicle, etc.).
- The vehicle is magnetized. (There is a magnet or a metal object near the inside rear view mirror.)
- The battery has been disconnected.
- Any door is open.

The compass works to calibrate the direction automatically while the vehicle is in motion, if deviation is small.

For obtaining additional precision or for complete calibrating, see "CALIBRATING THE COMPASS" below.

NOTICE

Do not put magnets or a metal object near the inside rear view mirror. Doing this may cause malfunction of the compass sensor.

CALIBRATING THE COMPASS (deviation calibration)

The direction display on the compass deviates from the true direction determined by the earth's magnetic field. The amount of deviation varies according to the geographic position of the vehicle.

To adjust for this deviation, stop the vehicle and push the button for longer than about 6 seconds until the number (1–15) appears on the display. Then push the button again, referring to the following map to select the number of the zone where the vehicle is.

COMFORT ADJUSTMENT

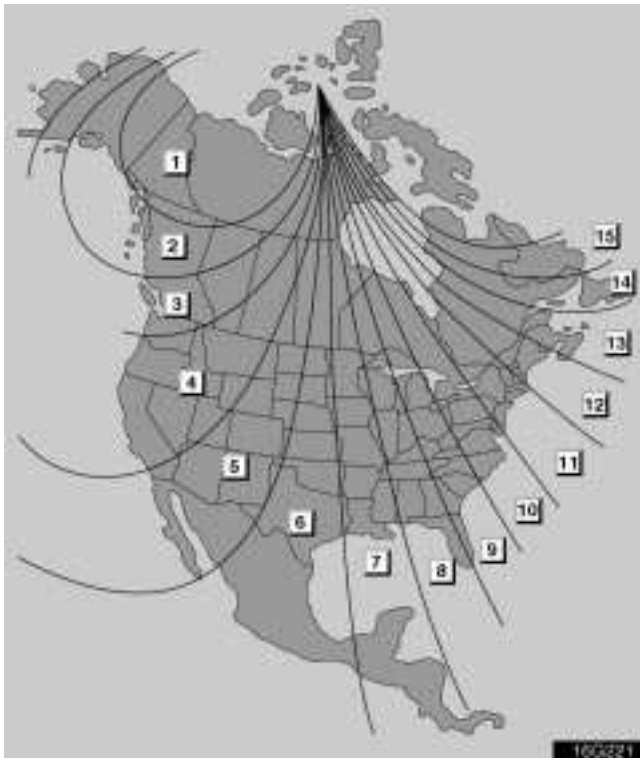

► **Zone number**

If the direction is displayed several seconds after adjustment, the calibration is finished.

CAUTION

Do not adjust the display while the vehicle is moving. Be sure to adjust the display only when the vehicle is stopped.

CALIBRATING THE COMPASS (circling calibration)



"C" appears on the display in case the circling calibration is required due to a drastic change in the magnetic field. To rectify this, follow the calibration procedure below.

COMFORT ADJUSTMENT

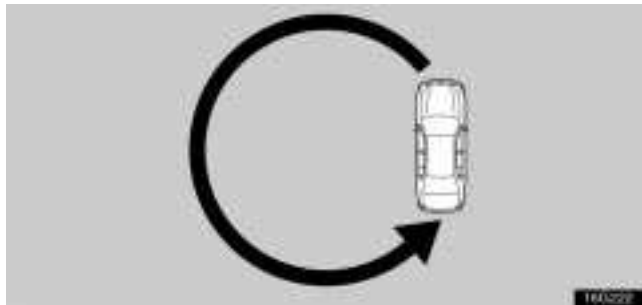

Drive the vehicle slowly (at 8 km/h (5 mph) or lower) in a circle until the direction is displayed. If there is not enough space to drive in a circle, drive around the block until the direction is displayed.

After driving in 1 to 3 circles in the above method, calibration is complete with the direction shown on the display.

If calibration cannot be performed because of the vehicle is magnetized, take your vehicle to a Lexus dealer.

- Do not perform circling calibration of the compass in a place where the earth's magnetic field is subject to interference by artificial magnetic fields (underground parking, under a steel tower, between buildings, roof parking, near a crossing, near a large vehicle, etc.).
- During calibration, do not operate electric systems (moon roof, power windows, etc.) as they may interfere with the calibration.



CAUTION

- When doing the circling calibration, be sure to secure a wide space, and watch out for people and vehicles in the neighborhood. Do not violate any local traffic rules while performing circling calibration.
- Do not adjust the display while the vehicle is moving. Be sure to adjust the display only when the vehicle is stopped.

COMFORT ADJUSTMENT

SEAT BELTS

Seat belt precautions

Lexus strongly urges that the driver and passengers in the vehicle be properly restrained at all times with the seat belts provided. Failure to do so could increase the chance of injury and/or the severity of injury in accidents.

The seat belts provided for your vehicle are designed for people of adult size, large enough to properly wear them.

Child. Use a child restraint system appropriate for the child until the child becomes large enough to properly wear the vehicle's seat belts. See "Child restraint" on page 111 for details.

If a child is too large for a child restraint system, the child should sit in the rear seat and must be restrained using the vehicle's seat belt. According to accident statistics, the child is safer when properly restrained in the rear seat than in the front seat.

If a child must sit in the front seat, the seat belts should be worn properly. Do not let the child sit on your lap. It does not provide sufficient restraint. If an accident occurs and the seat belts are not worn properly, the force of the rapid inflation of the airbag may cause severe injury to the child.

Do not allow the child to stand up or kneel on either rear or front seats. An unrestrained child could suffer serious injury or death during emergency braking or a collision.

Pregnant woman. Lexus recommends the use of a seat belt. Ask your doctor for specific recommendations. The lap belt should be worn securely and as low as possible over the hips and not on the waist.

Injured person. Lexus recommends the use of a seat belt. Depending on the injury, first check with your doctor for specific recommendations.

CAUTION

Persons should ride in their seats properly wearing their seat belts whenever the vehicle is moving. Otherwise, they are much more likely to suffer serious bodily injury or death in the event of sudden braking or a collision.

When using the seat belts, observe the following:

- Use the belt for only one person at a time. Do not use a single belt for two or more people – even children.
- Avoid reclining the seatbacks too much. The seat belts provide maximum protection when the seatbacks are in the upright position. (See "Adjusting seatback angle" on page 77.)
- Be careful not to damage the belt webbing or hardware. Take care that they do not get caught or pinched in the seat or doors.
- Inspect the belt system periodically. Check for cuts, fraying, and loose parts. Damaged parts should be replaced. Do not disassemble or modify the system.

COMFORT ADJUSTMENT

- **Keep the belts clean and dry. If they need cleaning, use a mild soap solution or lukewarm water. Never use bleach, dye, or abrasive cleaners – they may severely weaken the belts. (See "Cleaning the interior" on page 318 for instructions.)**
- **Replace the belt assembly (including bolts) if it has been used in a severe impact. The entire assembly should be replaced even if damage is not obvious.**

Fastening front and rear seat belts



Adjust the seat as needed and sit up straight and well back in the seat. To fasten your belt, pull it out of the retractor and insert the tab into the buckle.

You will hear a click when the tab locks into the buckle.

The seat belt length automatically adjusts to your size and the seat position.

The retractor will lock the belt during a sudden stop or on impact. It also may lock if you lean forward too quickly. A slow, easy motion will allow the belt to extend, and you can move around freely.

When a passenger's shoulder belt is completely extended and is then retracted even slightly, the belt is locked in that position and cannot be extended. This feature is used to hold the child restraint system securely. (For details, see "Child restraint" on page 111.) To free the belt again, fully retract the belt and then pull the belt out once more.

If the seat belt cannot be pulled out of the retractor, firmly pull the belt and release it. You will then be able to smoothly pull the belt out of the retractor.



CAUTION

- **After inserting the tab, make sure the tab and buckle are locked and that the belt is not twisted.**
- **Do not insert coins, clips, etc. in the buckle as this may prevent you from properly latching the tab and buckle.**
- **If the seat belt does not function normally, immediately contact your Lexus dealer. Do not use the seat until the seat belt is fixed. It cannot protect an adult occupant or your child from injury.**

COMFORT ADJUSTMENT



Adjust the position of the lap and shoulder belts.

- 1 Position the lap belt as low as possible on your hips – not on your waist.
- 2 Adjust it to a snug fit by pulling the shoulder portion upward through the latch plate.

CAUTION

- Both high-positioned lap belts and loose-fitting belts could cause serious injuries due to sliding under the lap belt during a collision or other unintended result. Keep the lap belt positioned as low on hips as possible.
- For your safety, do not place the shoulder belt under your arm.



Adjust the shoulder anchor position to your size.

To raise the anchor position, push the anchor up. To lower the anchor position, support the anchor while you push the lock release button then slide the anchor down. After adjustment, make sure the anchor is locked in position.

CAUTION

Always make sure the shoulder belt is positioned across the center of your shoulder. The belt should be kept away from your neck, but not falling off your shoulder. Failure to do so could reduce the amount of protection in an accident and cause severe injuries in a collision.



To release the belt, press the buckle release button and allow the belt to retract.

If the belt does not retract smoothly, pull it out and check for kinks or twists. Then make sure it remains untwisted as it retracts.

Seat belt comfort guides



The seat belt comfort guides are installed on the outside rear seats to relieve uncomfortableness from the shoulder belt when it is applied closer to a child's neck (at the age of 10 or so), by pulling the shoulder belt a little forward.

Slide the seat belt comfort guide forward to adjust the shoulder belt.

The seat belt comfort guide should not be in the forward position for other purposes.

COMFORT ADJUSTMENT



CAUTION

Always make sure the shoulder belt is positioned across the center of the child's shoulder. The belt should be kept away from the child's neck, and should not fall off the child's shoulder. Failure to observe these precautions could reduce the effectiveness of the seat belt in an accident, causing death or serious injury.

Seat belt extender

If your seat belts cannot be fastened securely because they are not long enough, a personalized seat belt extender is available from your Lexus dealer free of charge.

Please contact your local Lexus dealer to order the proper required length for the extender. Bring the heaviest coat you expect to wear for proper measurement and selection of length. Additional ordering information is available at your Lexus dealer.



CAUTION

When using the seat belt extender, observe the following precautions. Failure to follow these instructions could reduce the effectiveness of the seat belt restraint system in case of vehicle accident, increasing the chance of personal injury.

- Remember that the extender provided for you may not be safe when used on a different vehicle, for another person, or at a different seating position than the one originally intended.
- Be sure to wear the seat belt without the seat belt extender if you can fasten the seat belt without the extender.

- Do not use the seat belt extender when installing a child restraint system on the front or rear passenger seat. If installing a child restraint system with the seat belt extender connected to the seat belt, the seat belt will not securely hold the child restraint system, which could cause death or serious injury to the child or other passengers in the event of collision.



To connect the extender to the seat belt, insert the tab into the seat belt buckle so that the "PRESS" signs on the buckle release buttons of the extender and the seat belt are both facing outward as shown.

You will hear a click when the tab locks into the buckle.

When releasing the seat belt, press on the buckle release button on the extender, not on the seat belt. This helps prevent damage to the vehicle interior and extender itself.

When not in use, remove the extender and store in the vehicle for future use.



CAUTION

- After inserting the tab, make sure the tab and buckle are locked and that the belt is not twisted.
- Do not insert coins, clips, etc. in the buckle as this may prevent you from properly latching the tab and buckle.
- If the seat belt does not function normally, immediately contact your Lexus dealer. Do not use the seat until the seat belt is fixed. It cannot protect an adult occupant or your child from injury.

COMFORT ADJUSTMENT

Front seat belt pretensioners

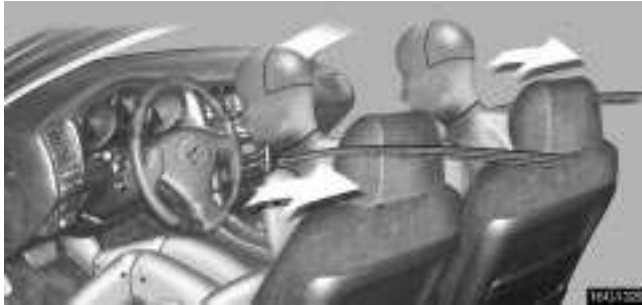

The driver and front passenger's seat belt pretensioners are designed to be activated in response to a severe frontal impact.

When the airbag sensor detects the shock of a severe frontal impact, the front seat belts are quickly drawn back by the retractor so that the belts snugly restrain the front seat occupants.

The front passenger seat belt pretensioner will not activate if there is no passenger sitting in the front passenger seat. However, the front passenger seat belt pretensioner may activate if luggage is put in the seat, or the seat belt is buckled up regardless of the presence of the occupant in the seat.

The seat belt pretensioners and SRS airbags may not operate together in case of collisions at certain speeds and angles.



This indicator comes on when the ignition key is turned to the "ON" position. It goes off after about 6 seconds. This means the front seat belt pretensioners are operating properly.

This warning light system monitors the airbag sensor assembly, front airbag sensors, side and curtain shield airbag sensors, occupant detection sensor, seat belt buckle switch, front seat belt pretensioner assemblies, inflators, warning light, interconnecting wiring and power sources. (For details, see "Service reminder indicators and warning buzzers" on page 40.)

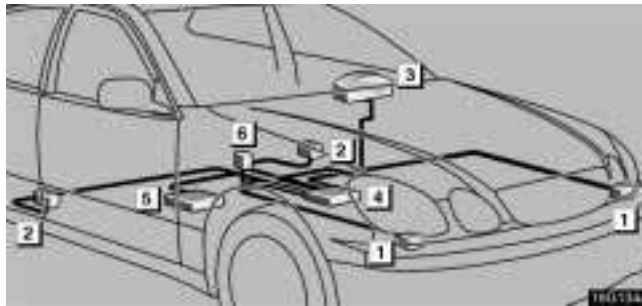

- ▶ **1 Front airbag sensor**
- 2 Front seat belt pretensioner assembly**
- 3 SRS warning light**
- 4 Airbag sensor assembly**
- 5 Occupant detection sensor**
- 6 Seat belt buckle switch**

The front seat belt pretensioner system consists mainly of the above components, and their locations are shown in the illustration.

The front seat belt pretensioners are controlled by the airbag sensor assembly. The airbag sensor assembly consists of a safing sensor and airbag sensor.

When the front seat belt pretensioners are activated, an operating noise may be heard and a small amount of smoke-like gas may be released. This gas is harmless and does not indicate that a fire is occurring.

Once the front seat belt pretensioners have been activated, the seat belt retractors remain locked.

CAUTION

Do not modify, remove, strike or open the front seat belt pretensioner assemblies, airbag sensor or surrounding area or wiring. Doing any of these may cause sudden operation of the front seat belt pretensioners or disable the system, which could result in death or serious injury.

Failure to follow these instructions can result in death or serious injury. Consult your Lexus dealer about any repairs and modifications.

NOTICE

Do not perform any of the following changes without consulting your Lexus dealer. Such changes can interfere with proper operation of the front seat belt pretensioners in some cases.

- *Installation of electronic devices such as a mobile two-way radio, cassette tape player or compact disc player.*
- *Repairs on or near the front seat belt retractor assemblies.*
- *Modification of the suspension system.*
- *Modification of the front end structure.*
- *Attachment of a grille guard (bull bar, kangaroo bar, etc.), snowplow, winches or any other equipment to the front end.*

COMFORT ADJUSTMENT

- *Repairs made on or near the front fenders, front end structure or console.*



This front seat belt pretensioner system has a service reminder indicator to inform the driver of operating problems. If any of the following conditions occurs, this indicates a malfunction of the pretensioners. Contact your Lexus dealer as soon as possible to service the vehicle.

- When the ignition key is turned to the "ON" position, the light does not come on or flashes.
- The light flashes while driving.
- If either front seat belt does not retract or cannot be pulled out due to a malfunction or activation of the relevant front pretensioner.

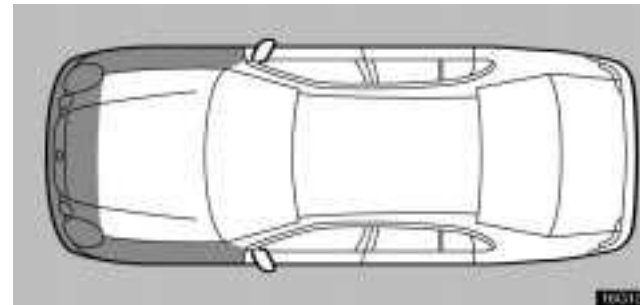

In the following cases, contact your Lexus dealer as soon as possible.

- The front of the vehicle (shaded in the illustration) were involved in an accident that did not cause the front seat belt pretensioners to operate.
- Either front seat belt pretensioner assembly or surrounding area is scratched, cracked, or otherwise damaged.

SRS AIRBAGS

The SRS (Supplemental Restraint System) airbags are designed to provide further protection for the driver and front passenger in addition to the primary safety protection provided by the seat belts.



► *Driver and front passenger airbags*

In response to a severe frontal impact, the driver and front passenger airbags work together with the seat belts to help reduce injury by inflating. The driver and front passenger airbags help to reduce injuries mainly to the driver's or front passenger's head or chest directly hitting the steering wheel or dashboard.

The front passenger airbag will not activate if there is no passenger sitting in the front passenger seat. However, the front passenger airbag may deploy if luggage is put in the seat, or the seat belt is buckled up regardless of the presence of the occupant in the seat.

Your vehicle is equipped with a crash sensing and diagnostic module, which will record the use of the seat belt restraint system by the driver when the front airbags are inflated.

Be sure to wear your seat belt properly.



CAUTION

The driver or front passenger who is too close to the steering wheel or dashboard during airbag deployment can be killed or seriously injured. Lexus strongly recommends that:

- The driver sit as far back as possible from the steering wheel while still maintaining control of the vehicle.
- The front passenger sit as far back as possible from the dashboard.
- All vehicle occupants be properly restrained using the available seat belts.

COMFORT ADJUSTMENT



► Side airbags

In response to a severe side impact, the side airbags for the driver or front passenger work together with the seat belts to help reduce injury by inflating. The side airbags help to reduce injuries mainly to the driver's or front passenger's chest.

The side airbag on the passenger seat will not activate if there is no passenger sitting in the front passenger seat. However, the side airbag on the passenger seat may deploy if luggage is put in the seat, or the seat belt is buckled up regardless of the presence of the occupant in the seat.

Your vehicle is equipped with a crash sensing and diagnostic module, which will record the use of the seat belt restraint system by the driver when the side airbags are inflated.

Be sure to wear your seat belt properly.

CAUTION

The side airbags inflate with considerable force. To avoid potential death or serious injury when they inflate, the driver and front passenger must:

- Wear their seat belts properly.
- Remain properly seated with their back upright and against the seat at all times.



► Curtain shield airbags

In response to a severe side impact, the curtain shield airbags for the driver or front passenger work together with the seat belts by inflating to help reduce injury mainly to the driver's or front passenger's head.

The curtain shield airbag is activated even with no passenger in the front seat.

Be sure to wear your seat belt properly.

Your vehicle is equipped with a crash sensing and diagnostic module, which will record the use of the seat belt restraint system by the driver when the curtain shield airbags are inflated.

CAUTION

The curtain shield airbags inflate with considerable force. To avoid potential death or serious injury when they inflate, the driver and front passenger must:

- Wear their seat belts properly.
- Remain properly seated with their back upright and against the seat at all times.



The indicator comes on when the ignition key is turned to the "ON" position. It goes off after about 6 seconds. This means the SRS airbags are operating properly.

This warning light system monitors the airbag sensor assembly, front airbag sensors, side and curtain shield airbag sensors, occupant detection sensor, seat belt buckle switch, front seat belt pretensioner assemblies, inflators, warning light, interconnecting wiring and power sources. (For details, see "Service reminder indicators and warning buzzers" on page 40.)

The front airbags are designed to deploy in severe (usually frontal) collisions where the magnitude and duration of the forward deceleration of the vehicle exceeds the designed threshold level.

The front airbags will work if the severity of the impact is above the designed threshold level, comparable to an approximate 25 km/h (15 mph) collision in the U.S.A. and 30 km (18 mph) collision in Canada when the vehicle has the impact straight into a fixed barrier that does not move or deform.

COMFORT ADJUSTMENT

However, this threshold velocity will be considerably higher if the vehicle strikes an object, such as a parked vehicle or sign pole, which can move or deform on impact, or if the vehicle is involved in an underride collision (e.g. a collision in which the front of the vehicle "underrides", or goes under, the bed of a truck, etc.).

It is possible that in some collisions where the forward deceleration of the vehicle is very close to the designed threshold level, the SRS airbags and the seat belt pretensioners may not activate together.

For the safety of all occupants, always wear your seat belts properly.

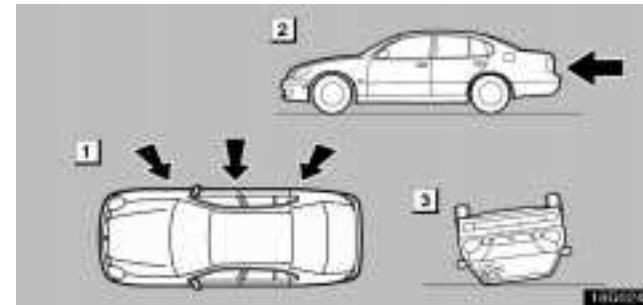

- **1** Collision from the side **2** Collision from the rear
3 Vehicle rollover

The front airbags are generally not designed to inflate if the vehicle is involved in a side or rear collision, if it rolls over, or if it is involved in a low-speed frontal collision. But, whenever a collision of any type causes sufficient forward deceleration of the vehicle, deployment of the front airbags may occur.

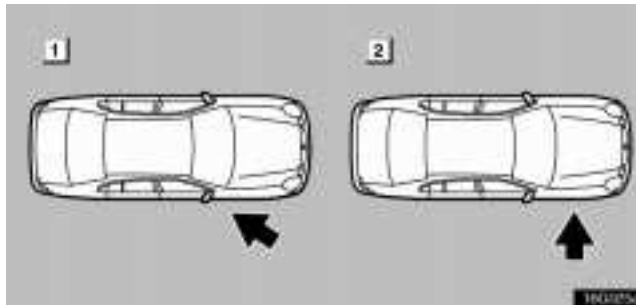

- ▶ **1** *Collision from the side at an angle*
- ▶ **2** *Collision from the side to the vehicle body other than the passenger compartment*

The side and curtain shield airbags may not inflate if the vehicle is subjected to a collision from the side at certain angles, or a collision to the side of the vehicle body other than the passenger compartment as shown in the illustration.

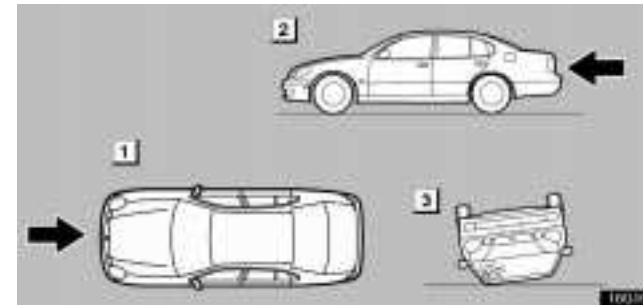

- ▶ **1** *Collision from the front*
- ▶ **2** *Collision from the rear*
- ▶ **3** *Vehicle rollover*

The side and curtain shield airbags are generally not designed to inflate if the vehicle is involved in a front or rear collision, if it rolls over, or if it is involved in a low-speed side collision.

COMFORT ADJUSTMENT

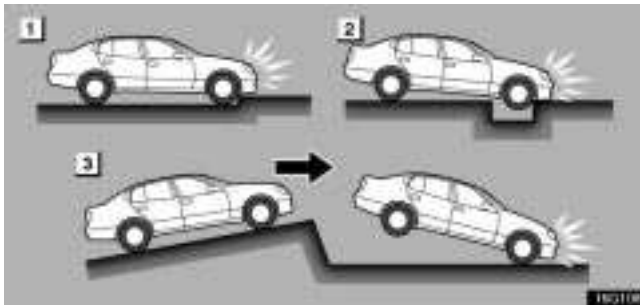

- ▶ **1** *Hitting a curb, edge of pavement or hard material*
- ▶ **2** *Falling into or jumping over a deep hole*
- ▶ **3** *Landing hard or vehicle falling*

The SRS airbags may also deploy if a serious impact occurs to the underside of your vehicle. Some examples are shown in the illustration.

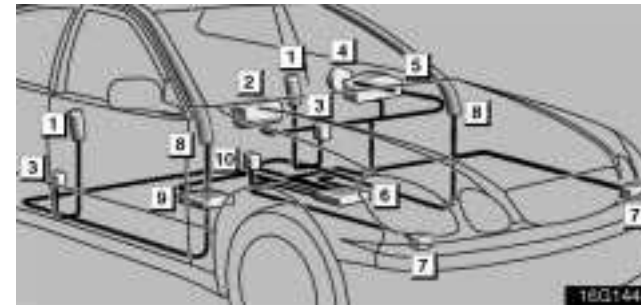

- ▶ **1** *Side airbag module (airbag and inflator)*
- ▶ **2** *Airbag module for front passenger (airbag and inflator)*
- ▶ **3** *Side and curtain shield airbag sensor assembly*
- ▶ **4** *Airbag module for driver (airbag and inflator)*
- ▶ **5** *SRS warning light*
- ▶ **6** *Airbag sensor assembly*
- ▶ **7** *Front airbag sensor*
- ▶ **8** *Curtain shield airbag module (airbag and inflator)*
- ▶ **9** *Occupant detection sensor*
- ▶ **10** *Seat belt buckle switch*

The SRS airbag system mainly consists of the above components, and their locations are shown in the illustration.

The airbag sensor assembly consists of a safing sensor and airbag sensors.

COMFORT ADJUSTMENT

The front airbag sensors constantly monitor the forward deceleration of the vehicle. If an impact results in a forward deceleration beyond the designed threshold level, the system triggers the airbag inflators. In a severe side impact, the side and curtain shield airbag sensor triggers the side and curtain shield airbag inflator. At this time a chemical reaction in the inflators very quickly fills the airbags with non-toxic gas to help restrain the forward or lateral motion of the occupants. The front airbags then quickly deflate, so that there is no obstruction of the driver's vision should it be necessary to continue driving.

When the airbags inflate, they produce a loud noise and release some smoke and residue along with non-toxic gas. This does not indicate a fire. This smoke may remain inside the vehicle for some time, and may cause some minor irritation to the eyes, skin or breathing. Be sure to wash off any residue as soon as possible to prevent any potential skin irritation with soap and water. If you can physically and safely exit the vehicle after a collision, you should do so at the first opportunity.

Deployment of the airbags happens in a fraction of a second, so the airbags must inflate with considerable force. While the system is designed to reduce serious injuries, primarily to the head and chest, it may also cause other, less severe injuries to the face, chest, arms and hands. These are usually in the nature of minor burns or abrasions and swelling, but the force of a deploying airbag can cause more serious injuries, especially if an occupant's hands, arms, chest or head is in close proximity to the airbag module at the time of deployment. This is why it is important for the occupant to; avoid placing any object or part of the body between the occupant and the airbag module; sit straight and well back into the seat; wear the available seat belt properly; and sit as far as possible from the airbag module, while still maintaining control of the vehicle.

Parts of the airbag module (steering wheel hub, airbag cover and inflator) may be hot for several minutes after deployment, so do not touch! The airbags inflate only once. The windshield may be damaged by absorbing some of the force of the inflating airbag.

COMFORT ADJUSTMENT

CAUTION

- The SRS airbag system is designed only as a supplement to the primary protection of the driver side and front passenger side seat belt systems. The front seat occupants can be killed or seriously injured by the inflating airbags if they do not wear the available seat belts properly. During sudden braking just before a collision, an unrestrained driver or front passenger can move forward into direct contact with or close proximity to the airbag which may then deploy during the collision. To ensure maximum protection in an accident, the driver and all passengers in the vehicle must wear their seat belts properly. Wearing a seat belt properly during an accident reduces the chances of death or serious injury or being thrown out of the vehicle. For instructions and precautions concerning the seat belt system, see "Seat belts" on page 88.
- Improperly seated and/or restrained infants and children can be killed or seriously injured by the deploying airbags. An infant or child who is too small to use a seat belt should be properly secured using a child restraint system. Lexus strongly recommends that all infants and children be placed in the rear seat of the vehicle and properly restrained. The rear seat is the safest for infants and children. For instructions concerning the installation of a child restraint system, see "Child restraint" on page 111 .



- Never put a rear-facing child restraint system on the front passenger seat because the force of the rapid inflation of the front passenger airbag can cause death or serious injury to the child.

COMFORT ADJUSTMENT



► **Move seat fully back**

- A forward-facing child restraint system should be allowed to be put on the front passenger seat only when it is unavoidable. Always move the seat as far back as possible, because the force of the deploying front passenger airbag could cause death or serious injury to the child.
- Do not allow the child to lean against the front door or around the front door even if the child is seated in a child restraint system. It is dangerous if the side airbag and curtain shield airbag inflate, because the impact could cause death or serious injury to the child.

For instructions concerning the installation of a child restraint system, see "Child restraint" on page 111.



- Do not sit on the edge of the seat or lean against the dashboard when the vehicle is in use, since the front passenger airbag inflates with considerable speed and force. Otherwise, you may be killed or seriously injured. Sit up straight and well back in the seat, and always use your seat belt properly.

COMFORT ADJUSTMENT



- Do not lean against the front door when the vehicle is in use, since the side airbag and curtain shield airbag inflate with considerable speed and force. Otherwise, you may be killed or seriously injured. Special care should be taken especially when you have a small child in the vehicle.
- Sit up straight and well back in the seat, distributing your weight evenly in the seat. Do not apply excessive weight to the outer side of the front seats on vehicles with side airbags.



- Do not get your head closer to the area where the side airbag and curtain shield airbag inflate, since these airbags inflate with considerable speed and force. Otherwise, you may be killed or seriously injured. Special care should be taken especially when you have a small child in the vehicle.
- Do not allow a child to kneel on the front passenger seat facing the front passenger's side door, since the side airbag and curtain shield airbag inflate with considerable speed and force. Otherwise, the child may be killed or seriously injured.

COMFORT ADJUSTMENT



- Do not allow a child to stand up or kneel on the front passenger seat, since the front passenger airbag inflates with considerable speed and force. Otherwise, the child may be killed or seriously injured.
- Do not hold a child on your lap or in your arms. Use a child restraint system in the rear seat. For instructions concerning the installation of a child restraint system, see "Child restraint" on page 111.



- Do not put objects or your pets on or in front of the dashboard or steering wheel pad that houses the driver and front passenger airbag system. They might restrict inflation or cause death or serious injury as they are projected rearward by the force of the deploying airbags. Likewise, the driver and front passenger should not hold objects in their arms or on their knees.

COMFORT ADJUSTMENT



- Do not attach a cup holder or any other device or object on or around the door. When the side airbag inflates, the cup holder or any other device or object will be thrown with great force, or the side airbag may not activate correctly, resulting in death or serious injury. Likewise, the driver and front passenger should not hold objects in their arms or on their knees.



- Do not attach a microphone or any other device or object around the part where the curtain shield airbag activates such as on the windshield glass, side door glass and front and side pillar. When the curtain shield airbag inflates, the microphone or other device or object will be thrown with great force or the curtain shield airbag may not activate correctly, resulting in death or serious injury.

- Do not use seat accessories which cover the parts where the side airbags inflate. Such accessories may prevent the side airbags from activating correctly, causing death or serious injury.
- Do not modify or remove any wiring. Do not modify, remove, strike or open any components, such as the steering wheel pad, steering wheel, column cover, front passenger airbag cover, front seats or airbag sensor assembly. Doing so may cause sudden SRS front airbags inflation or disable the system, which could result in death or serious injury.
- Do not modify or replace the seats or upholstery of front seats equipped with side airbags. Such changes may disable the system or cause the side airbags to inflate accidentally, resulting in death or serious injury.
- Do not disassemble or repair the front pillar and roof side rail containing the curtain shield airbags. Such changes may disable the system or cause the curtain shield airbags to inflate accidentally, resulting in death or serious injury.

Failure to follow these instructions can result in death or serious injury. Consult your Lexus dealer about any repairs and modifications.

NOTICE

Do not perform any of the following changes without consulting your Lexus dealer. Such changes can interfere with proper operation of the SRS airbag system in some cases.

- *Installation of electronic devices such as a mobile two-way radio, cassette tape player or compact disc player.*
- *Modification of the suspension system.*
- *Modification of the front end structure and side structure of the passenger compartment.*
- *Attachment of a grille guard (bull bar, kangaroo bar, etc.), snowplow, winches or any other equipment to the front end.*
- *Repairs made on or near the front fenders, front end structure, console, steering column, steering wheel, dashboard near the front passenger airbag or front seats.*

COMFORT ADJUSTMENT



This SRS airbag system has an indicator to inform the driver of operating problems. If either of the following conditions occurs, this indicates a malfunction of the airbags. Contact your Lexus dealer as soon as possible to service the vehicle.

- When the ignition key is turned to the "ON" position, the light does not come on, stays on or flashes.
- The light comes on or starts flashing while driving.

If the light stays on, it indicates that the driver and front passenger airbags have a problem. If the light flashes, the side and curtain shield airbags have a problem.



In the following cases, contact your Lexus dealer as soon as possible:

- Any of the SRS airbags have been inflated.
- The front of the vehicle and portion of the doors (shaded in the illustration) were involved in an accident that was not severe enough to cause the SRS airbags to inflate.

- The surface of the seats with the side airbags or the pad section of the steering wheel or front passenger airbag cover (shaded in the illustration) is scratched, cracked, or otherwise damaged.
- The portion of the front pillar and roof side rail garnish (padding) containing the curtain shield airbags inside (shaded in the illustration) is scratched, cracked, or otherwise damaged.

CHILD RESTRAINT

Child restraint precautions

Lexus strongly urges the use of child restraint systems for children small enough to use them.

The laws of all 50 states in the U.S.A. and Canada now require the use of a child restraint system.

Your vehicle conforms to SAE J1819.

If a child is too large for a child restraint system, the child should sit in the rear seat and must be restrained using the vehicle's seat belt. See "Seat belts" on page 88 for details.



CAUTION

- For effective protection in automobile accidents and sudden stops, a child must be properly restrained, using a seat belt or child restraint system depending on age and size. Holding a child in your arms is not a substitute for a child restraint system. In an accident, the child can be crushed against the windshield, or between you and the vehicle's interior if you are unrestrained.
- Lexus strongly urges use of a proper child restraint system which conforms to the size of the child, installed on the rear seat. According to accident statistics, the child is safer when properly restrained in the rear seat than in the front seat.

COMFORT ADJUSTMENT

- **Never put a rear-facing child restraint system on the front seat. In the event of an accident, the force of the rapid inflation of the airbag can cause death or serious injury if a rear-facing child restraint system is put on the front seat.**
- **A forward-facing child restraint system should be allowed to be put on the front passenger seat only when it is unavoidable. Always move the seat as far back as possible, because the force of the deploying front passenger airbag could cause death or serious injury to the child.**
- **Make sure you have complied with all installation instructions provided by the child restraint manufacturer and that the system is properly secured.**
- **Do not use the seat belt extender when installing a child restraint system on the front or rear passenger seat. If installing a child restraint system with the seat belt extender connected to the seat belt, the seat belt will not securely hold the child restraint system, which could cause death or serious injury to the child or other passengers in the event of collision.**
- **Do not allow the child to lean against the front door or around the front door even if the child is seated in a child restraint system. It is dangerous if the side airbag and curtain shield airbag inflate, because the impact could cause death or serious injury to the child.**

Child restraint system

A child restraint system for a small child or baby must itself be properly restrained on the seat with the lap portion of the lap/shoulder belt. You must carefully consult the manufacturer's instructions which accompany the child restraint system.

To provide proper restraint, use a child restraint system following the manufacturer's instructions about the appropriate age and size of the child for the restraint system.

Install the child restraint system correctly following the instructions provided by its manufacturer. General directions are also provided under the following illustrations.

The child restraint system should be installed on the rear seat. According to accident statistics, the child is safer when properly restrained in the rear seat than in the front seat.

COMFORT ADJUSTMENT

CAUTION

- **Never put a rear-facing child restraint system on the front seat. In the event of an accident, the force of the rapid inflation of the airbag can cause death or serious injury if a rear-facing child restraint system is put on the front seat.**
- **A forward-facing child restraint system should be allowed to be put on the front passenger seat only when it is unavoidable. Always move the seat as far back as possible, because the force of the deploying front passenger airbag could cause death or serious injury to the child.**
- **Do not allow the child to lean against the front door or around the front door even if the child is seated in a child restraint system. It is dangerous if the side airbag and curtain shield airbag inflate, because the impact could cause death or serious injury to the child.**
- **After installing the child restraint system, make sure it is secured in place according to the manufacturer's instructions. If it is not restrained securely, it may cause death or serious injury to the child in the event of a sudden stop or accident.**

When not using the child restraint system, keep it secured with the seat belt or place it in the trunk or somewhere other than in the passenger compartment. This will prevent it from injuring passengers in the event of a sudden stop or accident.

Your vehicle has anchor brackets for securing the top strap of a child restraint system.

For instructions about how to use the anchor bracket, see "Using a top strap" on page 126.

COMFORT ADJUSTMENT

Types of child restraint system

Child restraint systems are classified into the following 3 types depending on the child's age and size.

- (A) Infant seat
- (B) Convertible seat
- (C) Booster seat

Install the child restraint system following the instructions provided by its manufacturer.

Child restraint lower anchorages approved for your vehicle may also be used. See "Installation with child restraint lower anchorages" on page 127.

(A) Infant seat

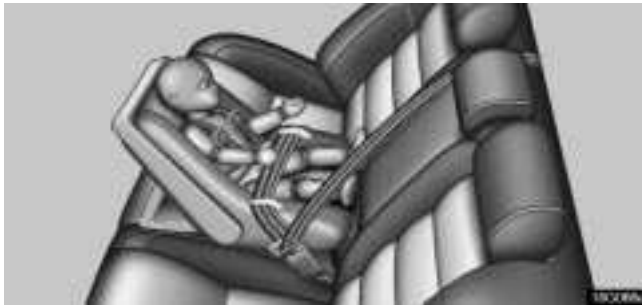

(B) Convertible seat



(C) Booster seat



INSTALLATION WITH 3-POINT TYPE SEAT BELT

(A) Infant seat installation

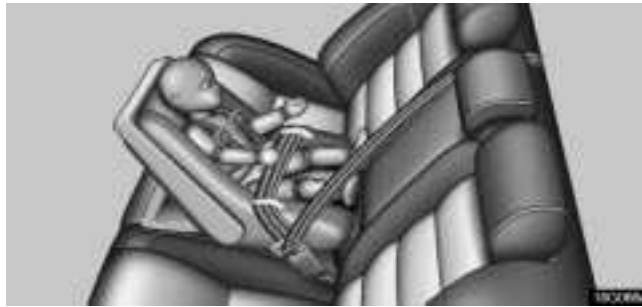

An infant seat is used in rear-facing position only.



 **CAUTION**

- Never put a rear-facing child restraint system on the front passenger seat because the force of the rapid inflation of the front passenger airbag can cause death or serious injury to the child.

COMFORT ADJUSTMENT



- If the driver's seat position does not allow sufficient space for safe installation, install the child restraint system on the rear right seat.



1. Run the lap and shoulder belt through or around the infant seat following the instructions provided by its manufacturer and inserting the tab into the buckle taking care not to twist the belt. Keep the lap portion of the belt tight.

CAUTION

- After inserting the tab, make sure the tab and buckle are locked and that the lap and shoulder portions of the belt are not twisted.
- Do not insert coins, clips, etc. in the buckle as this may prevent you from properly latching the tab and buckle.
- If the seat belt does not function normally, immediately contact your Lexus dealer. Do not use the child restraint system until the seat belt is fixed. It cannot protect your child from injury.

COMFORT ADJUSTMENT

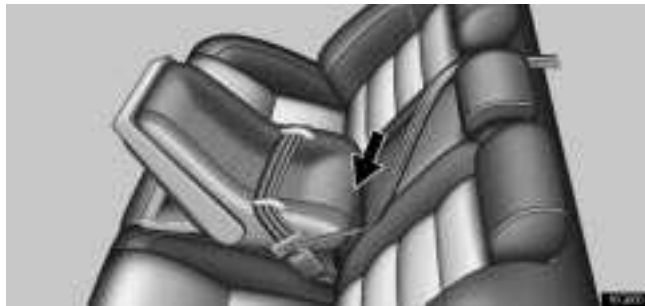

2. Fully extend the shoulder belt to put it in the lock mode. When the belt is then retracted even slightly, it cannot be extended.

To hold the infant seat securely, make sure the belt is in the lock mode before letting the belt retract.



3. While pressing the infant seat firmly against the seat cushion and seatback, let the shoulder belt retract as far as it will go to hold the infant seat securely.

COMFORT ADJUSTMENT



CAUTION

Push and pull the child restraint system in different directions to be sure it is secure. Follow all the installation instructions provided by its manufacturer.



4. To remove the infant seat, press the buckle-release button and allow the belt to retract completely. The belt will move freely again and be ready to work for an adult or older child passenger.

(B) Convertible seat installation



A convertible seat is used in forward-facing or rear-facing position depending on the age and size of the child. When installing, follow the manufacturer's instructions about the appropriate age and size of the child as well as directions for installing the child restraint system.



⚠ CAUTION

- **Never put a rear-facing child restraint system on the front passenger seat because the force of the rapid inflation of the front passenger airbag can cause death or serious injury to the child.**

COMFORT ADJUSTMENT



► *Move seat fully back*

- A forward-facing child restraint system should be allowed to be put on the front passenger seat only when it is unavoidable. Always move the seat as far back as possible, because the force of the deploying front passenger airbag could cause death or serious injury to the child.
- Do not allow the child to lean against the front door or around the front door even if the child is seated in a child restraint system. It is dangerous if the side airbag and curtain shield airbags inflate, because the impact could cause death or serious injury to the child.



- If the driver's seat position does not allow sufficient space for safe installation, install the child restraint system on the rear right seat.

COMFORT ADJUSTMENT



1. Run the lap and shoulder belt through or around the convertible seat following the instructions provided by its manufacturer and inserting the tab into the buckle taking care not to twist the belt. Keep the lap portion of the belt tight.



2. Fully extend the shoulder belt to put it in the lock mode. When the belt is then retracted slightly, it cannot be extended.

To hold the convertible seat securely, make sure the belt is in the lock mode before letting the belt retract.

CAUTION

- After inserting the tab, make sure the tab and buckle are locked and that the lap and shoulder portions of the belt are not twisted.
- Do not insert coins, clips, etc. in the buckle as this may prevent you from properly latching the tab and buckle.
- If the seat belt does not function normally, immediately contact your Lexus dealer. Do not use the child restraint system until the seat belt is fixed. It cannot protect your child from injury.

COMFORT ADJUSTMENT



3. While pressing the convertible seat firmly against the seat cushion and seatback, let the shoulder belt retract as far as it will go to hold the convertible seat securely.



CAUTION

Push and pull the child restraint system in different directions to be sure it is secure. Follow all the installation instructions provided by its manufacturer.

COMFORT ADJUSTMENT



4. To remove the convertible seat, press the buckle–release button and allow the belt to retract completely. The belt will move freely again and be ready to work for an adult or older child passenger.

(C) Booster seat installation



A booster seat is used in forward–facing position only.

COMFORT ADJUSTMENT



► **Move seat fully back**



CAUTION

- A forward-facing child restraint system should be allowed to be put on the front passenger seat only when it is unavoidable. Always move the seat as far back as possible, because the force of the deploying front passenger airbag could cause death or serious injury to the child.
- Do not allow the child to lean against the front door or around the front door even if the child is seated in a child restraint system. It is dangerous if the side airbag and curtain shield airbags inflate, because the impact could cause death or serious injury to the child.



1. Sit the child on a booster seat. Run the lap and shoulder belt through or around the booster seat and across the child following the instructions provided by its manufacturer and insert the tab into the buckle.

Make sure the shoulder belt is correctly across the child's shoulder and that the lap belt is positioned as low as possible on child's hips. See "Seat belts" on page 88 for details.



CAUTION

- Always make sure the shoulder belt is positioned across the center of child's shoulder. The belt should be kept away from child's neck, but not falling off child's shoulder. Failure to do so could reduce the amount of protection in an accident and cause serious injuries in a collision.

COMFORT ADJUSTMENT

- Both high-positioned lap belts and loose-fitting belts could cause serious injuries due to sliding under the lap belt during a collision or other unintended result. Keep the lap belt positioned as low on a child's hips as possible.
- For child's safety, do not place the shoulder belt under child's arm.
- After inserting the tab, make sure the tab and buckle are locked and that the lap and shoulder portions of the belt are not twisted.
- Do not insert coins, clips, etc. in the buckle as this may prevent your child from properly latching the tab and buckle.
- If the seat belt does not function normally, immediately contact your Lexus dealer. Do not use the child restraint system until the seat belt is fixed. It cannot protect your child from injury.



2. To remove the child restraint system, press the buckle-release button and allow the belt to retract.

COMFORT ADJUSTMENT

Using a top strap

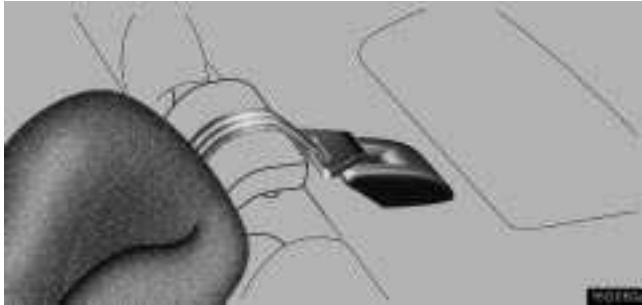

Follow the procedure below for a child restraint system that requires the use of a top strap.

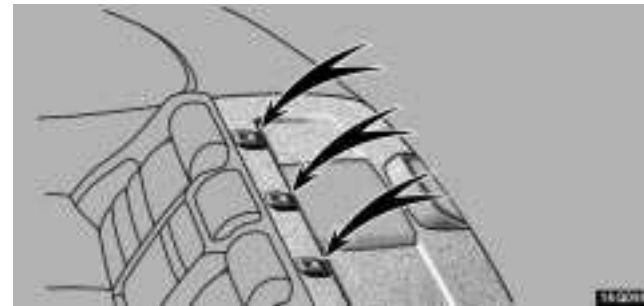

► *Anchor brackets*

Use the anchor bracket on the package tray behind the rear seat to attach the top strap.

Anchor brackets are installed for each rear seating position.

COMFORT ADJUSTMENT



1. Fix the child restraint system with the seat belt.
2. Latch the hook onto the anchor bracket and tighten the top strap.

For instructions to install the child restraint system, see "Type of child restraint system" on page 114.

CAUTION

- Make sure the top strap is securely latched, and check that the child restraint system is secure by pushing and pulling it in different directions.
- Follow all the installation instructions provided by its manufacturer.

INSTALLATION WITH CHILD RESTRAINT LOWER ANCHORAGES

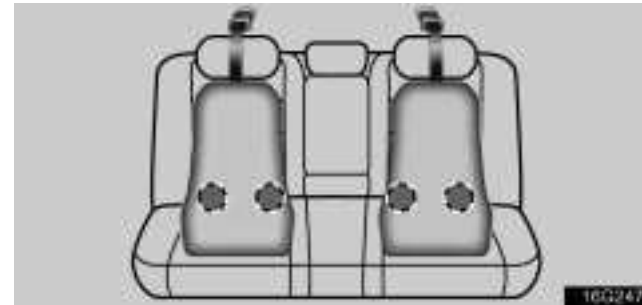

The lower anchorages for the child restraint system interfaced with the FMVSS225 or CMVSS210.2 specification are installed in the rear seat.

The anchorages are installed in the clearance between the seat cushion and seatback of both outside rear seats.

Child restraint system interfaced with the FMVSS225 or CMVSS210.2 specification can be fixed with these anchorages. In this case, it is not necessary to fix the child restraint system with a seat belt on the vehicle.

COMFORT ADJUSTMENT



► **Type A**



► **Type B**

For owners in Canada

The symbol on a child restraint system indicates the presence of a lower connector system.

CHILD RESTRAINT SYSTEM INSTALLATION

Type A:

- 1. Widen the clearance between the seat cushion and seatback a little and confirm the position of the lower anchorages below the tag in the seatback.**
- 2. Latch the hooks of lower straps onto the anchorages and tighten the lower straps.**

Type B:

- 1. Widen the clearance between the seat cushion and seatback a little and confirm the position of the lower anchorages below the tag in the seatback.**
- 2. Latch the buckles onto the anchorages**

If your child restraint system has a top strap, it should be anchored. (For the installation of the top strap, see "Using a top strap" on page 126.)

For the installation details, refer to the instruction manual equipped with each product.



CAUTION

- **When using the lower anchorages for the child restraint system, be sure that there are no irregular objects around the anchorages or that the seat belt is not caught.**
- **Push and pull the child restraint system in different directions to be sure it is secure. Follow all the installation instructions provided by its manufacturer.**

COMFORT ADJUSTMENT

DRIVING POSITION MEMORY SYSTEM

A microcomputer will memorize the position of the driver's seat, and the positions of the tilt and telescopic steering, and outside rear view mirrors. Two different driving position profiles can be entered into the computer's memory.

Recording a driving position in the computer's memory can only be done when the ignition key is in the "ON" position and the selector lever is in the "P" position.

Setting the driving position



1. Adjust the driver's seat, tilt and telescopic steering and outside rear view mirrors to the desired position.
2. While pushing the "SET" button, push button "1" or "2" until the signal beeps.

The beep sound means that the positions are recorded in the computer's memory.

By repeating these two steps and pressing the remaining button, the driving position for another driver can be recorded.

To set a new memorized position, select the desired position and perform step 2. The previous memory will be erased and the new position will be set.

To make only slight changes to an already memorized position, the easiest way is to first activate the memorized position, then make the desired changes and perform step 2 above.

Recalling the memorized position



When you push button "1" or "2", the driving position will be automatically adjusted to the position recorded for that button.

Conditions for memorized position activation

- Ignition key "ON" and selector lever in "P" position.
All parts of the memorized positions can be activated.
However, if the brake pedal is being depressed, the seat position will not change.
- Key not in ignition switch and within 30 seconds of opening driver's door.
The memorized position can be activated, except for the tilt and telescopic steering.

If any driving position memory switch is pushed while one of the memorized driving position profiles is being activated, the operation will stop.

To activate the system, push the desired button ("1" or "2") again.

The driving position memory control system cannot be operated while the vehicle is moving.

If the vehicle's battery is disconnected, the computer's memory will be erased and the memorized positions will have to be set again.



CAUTION

- Do not start the vehicle while the adjustments are being made.
- Take care not to select the wrong button, or the seat could strike the rear passenger or hit your body against the steering wheel. If this happens, you can stop the movement by pressing another driving position memory switch, or depressing the brake pedal.

SECTION 1 - 7

INSTRUMENTS AND CONTROLS

Theft deterrent

Theft deterrent system	134
Theft prevention labels	136

THEFT DETERRENT

THEFT DETERRENT SYSTEM



To deter theft of the vehicle, this system is designed to sound an alarm if any of the doors, trunk or hood is forcibly unlocked or the battery terminal is disconnected and then reconnected while the vehicle is locked.

The alarm blows the vehicle's horn and intermittently flashes the headlights, tail lights and other exterior lights.



► *Security indicator light*

Setting the system

1. Turn the ignition key to the "LOCK" position and remove it.

The engine immobiliser system causes the indicator light to flash.

2. Close and lock all the doors, trunk and hood using an ignition key or wireless remote control.

The flashing indicator light will remain on when all the doors, trunk and hood are closed and locked.

3. After 30 seconds, the indicator starts flashing and the system is set.

Cancelling the system

When you unlock any door or trunk using an ignition key or wireless remote control, the system is cancelled.

Activating the system

The alarm sounds for 60 seconds if any of the following are operated:

- Unlocking any door or trunk without using an ignition key or wireless remote control.
- Opening the hood forcibly.
- Reconnecting the battery.

If any door is unlocked during the alarm sounding, its door is automatically locked.

To stop the alarm: Use either of the following methods.

- Unlock the door or trunk using an ignition key or wireless remote control.
- Turn the ignition switch on.

Testing the system

- 1. Open all the windows.**
- 2. Set the system as described above.**

The front doors should be locked with the ignition key or wireless remote control. Be sure to wait until the indicator light starts flashing.

- 3. Unlock one of the doors from the inside through one of the opened windows.**

The system should activate the alarm.

- 4. Unlock any of the doors with a key or the wireless remote control to cancel the system.**

- 5. Repeat this operation for the other doors, trunk and hood.**

When testing the hood, also check that the system is activated when the battery terminal is disconnected and then reconnected.

If the system does not work properly, have it checked by your Lexus dealer.

THEFT DETERRENT

NOTICE

Disconnecting the battery may result in the erasure of information you have set in the computer memory. After reconnecting the battery, check that the memorized data has been retained. If it has been erased, input it into the computer once more.

THEFT PREVENTION LABELS (U.S.A. ONLY)

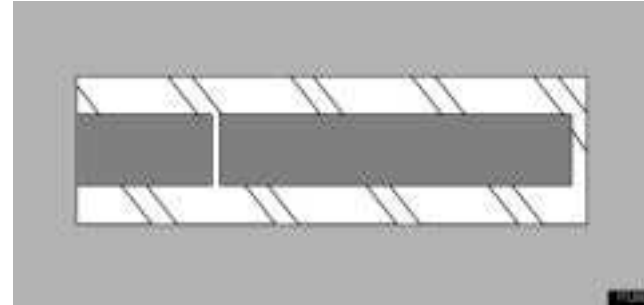

Your new vehicle carries theft prevention labels which are approximately 56 mm (2.20 in.) by 16 mm (0.63 in.).

The purpose of these labels is to reduce the incidence of vehicle thefts by facilitating the tracing and recovery of parts from stolen vehicles. The label is designed so that once it is applied to a surface, any attempt to remove it will result in destroying the integrity of the label. Transferring these labels intact from one part to another will be impossible.

NOTICE

You should not attempt to remove the theft prevention labels as it may violate certain state or federal laws.

SECTION 2-1

AIR CONDITIONING AND AUDIO

Air conditioning

Automatic air conditioning controls 138

For vehicles equipped with Navigation System, please refer to the separate "Navigation System Owner's Manual".

AIR CONDITIONING

AUTOMATIC AIR CONDITIONING CONTROLS

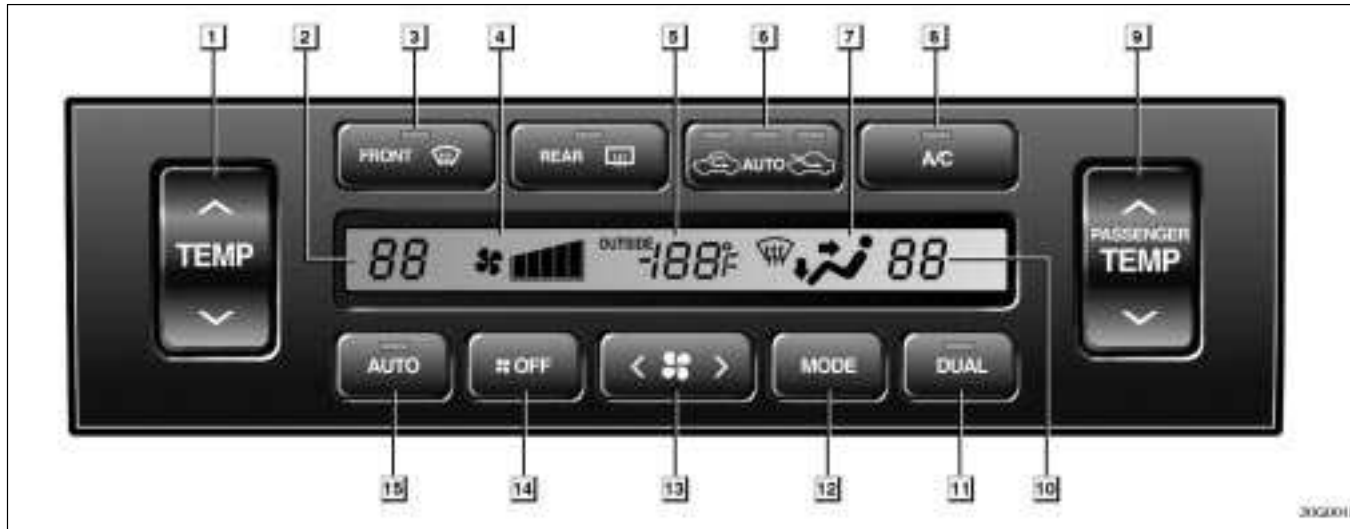

- **The automatic air conditioning automatically maintains the set temperature.**

In the automatic operation mode, the air conditioning selects the most suitable fan speed, air flow, air intake and on-off of the air conditioning according to the temperature.

The ignition key must be in the "ON" position.

NOTICE

To prevent the battery from being discharged, do not leave the air conditioning on longer than necessary when the engine is not running.

- 1** *Driver side temperature control button*
- 2** *Driver side temperature display (in degrees Fahrenheit or Centigrade)*
- 3** *Front windshield button*
- 4** *Fan speed display*
- 5** *Outside temperature display (in degrees Fahrenheit or Centigrade)*
- 6** *Air intake control button*
- 7** *Air flow display*
- 8** *Air conditioning on–off button*
- 9** *Passenger side temperature control button*
- 10** *Passenger side temperature display (in degrees Fahrenheit or Centigrade)*
- 11** *Separate/dual control button*
- 12** *Air flow control button*
- 13** *Fan speed control button*
- 14** *OFF button*
- 15** *Automatic control button*

AIR CONDITIONING

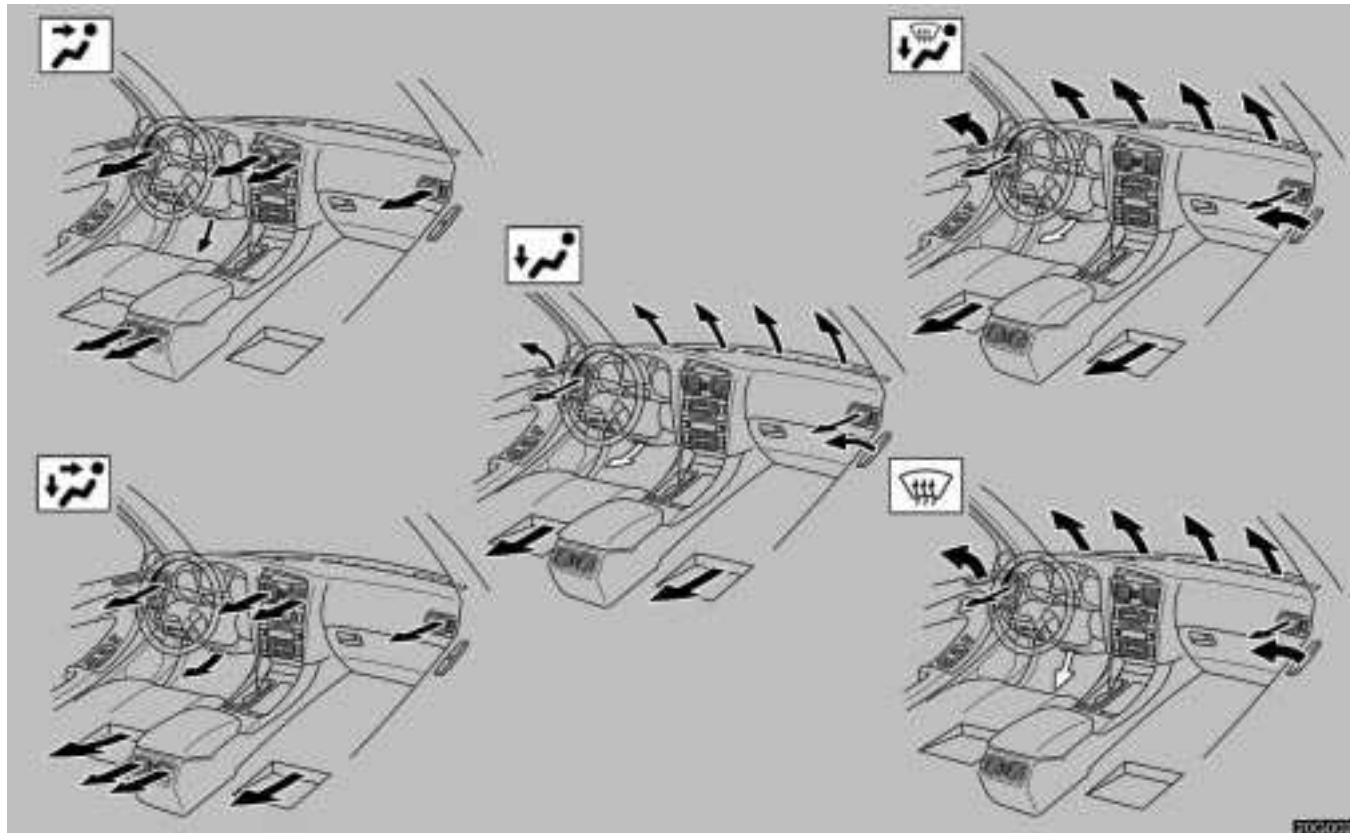

► **Air flow selection**

⇒ See “Lower vent” on page 149.

(a) Climate control

SETTING OPERATION – automatic control



1. Push the "AUTO" button.

Air flow quantity, switching of the diffusers, on-off of the air conditioning, and switching of the air intake between RECIRCULATED AIR and OUTSIDE AIR are automatically adjusted. The operation status is shown by each indicator.

When one of the manual control buttons is depressed while operating in automatic mode, the mode relevant to the depressed button is set. Other conditions continue to be adjusted automatically.

It is recommended that you close the lower vent. For details about this, see page 149.

Push the "OFF" button to turn the air conditioning off.



2. Use the "TEMP" or "PASSENGER TEMP" button to set the desired temperature.

The temperature will be controlled on the driver and passenger sides simultaneously or individually.

"TEMP" button – Changes the temperature on the driver and passenger sides simultaneously or the driver side only.

"PASSENGER TEMP" button – Changes the temperature settings separate from the driver side.

"DUAL" button – Changes the mode of the temperature setting.

The indicator on the "DUAL" button has two modes:

- **With the indicator on** – For individual temperature setting
- **With the indicator off** – For simultaneous temperature setting

AIR CONDITIONING

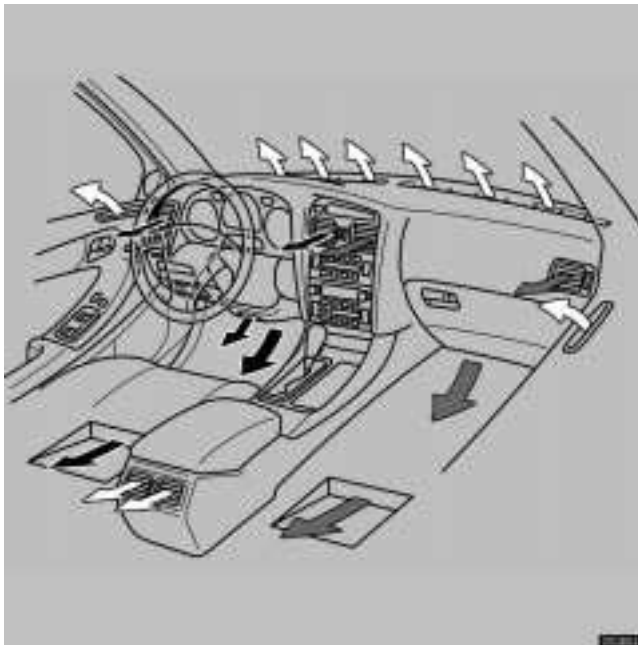

- ➔ Driver side setting
- ➞ Passenger side setting
- ⇨ Mixed setting

SETTING OPERATION – manual control

When one of the manual control buttons is depressed while operating in automatic mode, the mode relevant to the depressed button is set. Other conditions continue to be adjusted automatically.

If manual air flow selection is desired –



The outlets from which air is delivered can be selected manually by pushing the button. The function of each mode is as follows:

- 1 Panel** – Air flows mainly from the instrument panel vents.
- 2 Bi-level** – Air flows from both the floor vents and the instrument panel vents.
- 3 Floor** – Air flows mainly from the floor vents.

It is recommended that you close the lower vent. For details about this, see page 149.

- 4 **Floor/Windshield** – Air flows mainly from the floor vents and windshield vents.

It is recommended that you close the lower vent. For details about this, see page 149.

If quick heating or cooling is desired –

Push the "TEMP" or "PASSENGER TEMP" button on either side and hold it until the maximum figure or minimum figure appears on the display.

If manual fan speed control is desired –



- ▶ 1 **Fan speed at low** 2 **Fan speed at high**

The fan speed can be set to your desired speed by pushing the appropriate side of fan speed control button. The higher the fan speed is, the more air is delivered. Pushing the "OFF" button turns off the fan.

To remove exterior windshield frost, use the high speed setting.

If manual switching of air intake is desired –

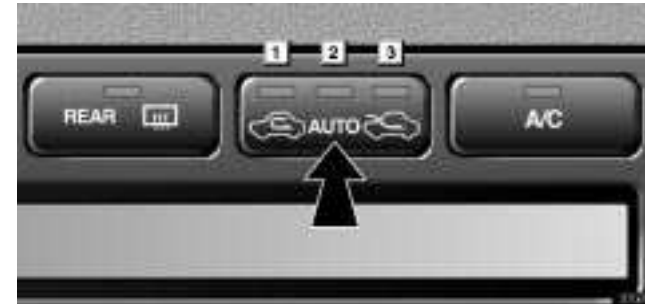

Each time you push the air intake control button, the mode changes in order from the RECIRCULATED AIR mode to AUTOMATIC mode to OUTSIDE AIR mode, then back to the RECIRCULATED AIR mode. Each indicator light shows which mode is now selected.

- 1 **RECIRCULATED mode** – If quick circulation of cooled air is desired, select this mode.
- 2 **EXHAUST GAS AUTOMATIC mode** – If the outside air contains harmful substances like exhaust gas (i.e., when the vehicle running just in front of your vehicle accelerates rapidly), the system changes automatically from the OUTSIDE AIR mode (with indicators 2 and 3 on) to the RECIRCULATED mode (with indicators 1 and 2 on).
- 3 **OUTSIDE AIR mode** – The system will take fresh outside air into the vehicle.

AIR CONDITIONING

Turning off the air conditioning manually will cancel the EXHAUST GAS AUTOMATIC mode. If you select the "AUTO" mode during fan operating, the air conditioning turns on and the EXHAUST GAS AUTOMATIC mode will operate.

For normal use, it is best to keep the air intake control button set to OUTSIDE AIR mode. If recirculated air is used during heating, the windows will fog up more easily.

To change the sensitivity of the sensor switching between the RECIRCULATED and OUTSIDE AIR in the AUTOMATIC mode, push the air intake control button until the "AUTO" indicator light flashes. The display changes as illustrated below.

The sensitivity of the sensor can be adjusted only while the vehicle has stopped.



Each time you push the "TEMP" button, the sensitivity changes from "+3" down to "-3". If you do not operate any button for a few seconds or if you push a button other than the air intake control button and driver side temperature control button, the previous display returns.

If manual on-off of the air conditioning is desired –

Push the "A/C" button to turn the air conditioning on and push it again to turn the air conditioning off. If you turn off the air conditioning manually, the EXHAUST GAS AUTOMATIC mode will be cancelled.

If the outside temperature is lowered down to around 0°C (32°F), the air conditioning will turn off automatically. At this time, the indicator on the A/C button is off and the EXHAUST GAS AUTOMATIC indicator light remains on. However, the EXHAUST GAS AUTOMATIC mode does not operate. When the air conditioning turns on as with the raised temperature, the EXHAUST GAS AUTOMATIC mode resumes.

If the system is used for ventilation, heating in dry weather or removing frost or exterior fog on the windshield, turn the air conditioning off once it is no longer required. This will improve fuel economy. The air conditioning can be used for year-round automatic temperature control including cooling and dehumidifying operation.

If the air conditioning compressor does not operate, the indicator of the "A/C" button will blink. If the indicator of the "A/C" button blinks even when the "A/C" button is pushed again, have the compressor checked by your nearest Lexus dealer.

Displaying the outside temperature –

The temperature display ranges from -30°C (-22°F) up to 50°C (122°F).

(b) Windshield defogging and defrosting



To remove interior fog on the windshield –

Push the "FRONT WINDSHIELD" button.

To remove frost or exterior fog on the windshield –

1. Place the temperature control button at the maximum temperature.
2. Push the "FRONT WINDSHIELD" button.
3. Push the fan speed control button on the right side to obtain a maximum air flow.
4. Leave the air conditioning on-off button off.

For further information for removing frost and fog, see "Lower vent" on page 149.

AIR CONDITIONING

When the "FRONT WINDSHIELD" button is pushed while operating in automatic mode, the air conditioning is set to operate and the OUTSIDE AIR mode is set.

If you push the "FRONT WINDSHIELD" button once again while in the FRONT WINDSHIELD mode, the mode then returns to the last mode used.

CAUTION

Do not use the "FRONT WINDSHIELD" button during cooled air operation in extremely humid weather. The difference between the temperature of the outside air and that of the windshield could cause the outer surface of the windshield to fog up blocking your vision.

(c) Air conditioning filter



The air conditioning filter information label is placed in the glove box as shown and indicates that a filter has been installed.

The air conditioning filter prevents dust from entering the vehicle through the air conditioning vent.

The air conditioning filter is behind the glove box.

The air conditioning filter may clog after long use which will reduce the air flow. However, you can inspect the filter easily.

When you inspect and replace the filter, be sure to turn off the fan.

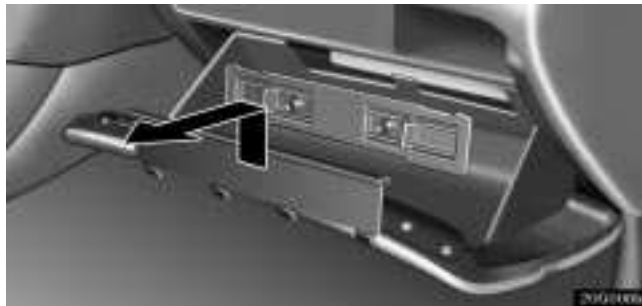

1. Open the glove box and remove the two covers.



2. Take out the filter.

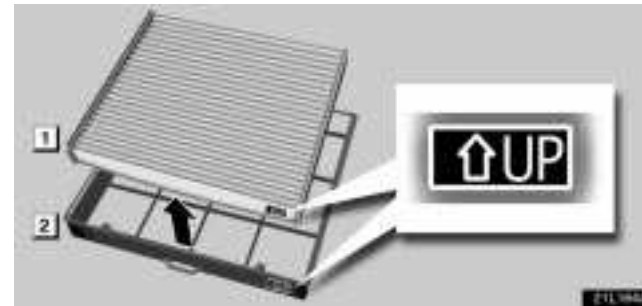

► 1 Filter 2 Filter case

3. Remove the filter from the filter case.

4. Inspect the filter on the surface.

If it is dirty, it should be replaced. To maintain the air conditioning efficiency, replace the filter according to the maintenance schedule. (For scheduled maintenance information, please refer to the "Owner's Manual Supplement/Scheduled Maintenance".)

NOTICE

When setting the filter to the filter case, the UP marks shown on the filter and filter case should be noted and fitted as shown.

AIR CONDITIONING

INFORMATION

The filter should be installed properly in position. The use of air conditioning with the filter removed may cause deteriorated dustproof performance and then affect air conditioning performance.

(d) Operating tips

- Make sure the air inlet grilles in front of the windshield are not blocked by leaves or other obstructions.
- If air flow control is not satisfactory, check the dashboard vents. (See "Center vents", "Side vents", "Lower vent" and "Rear vents".)
- To help cool down the interior after parking in the hot sun, drive for the first few minutes with the windows open. After the excess heat has blown away, close the windows.
- When driving on dusty roads, close all windows. If dust thrown up by the vehicle is still drawn into the vehicle after closing the windows, it is recommended that the air intake control button be left to the OUTSIDE AIR mode and the fan speed control button be pressed to anywhere except the "OFF" button.
- If following another vehicle on a dusty road, or driving in windy and dusty conditions, it is recommended that the air intake control button be temporarily pressed in to the RECIRCULATED AIR mode, which will close off the outside passage and prevent outside air and dust from entering the vehicle interior.

Center vents

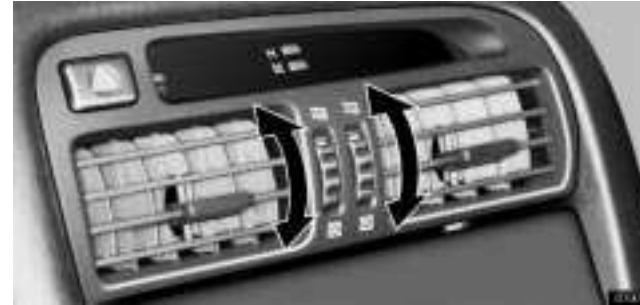

The center vents may be opened or closed as shown.

Side vents



The side vents may be opened or closed as shown.

Lower vent



The lower vent may be opened or closed as shown.

For removing frost or fog, it is recommended that you close the lower vent when you push the "FRONT WINDSHIELD" button or use the "Floor" or the "Floor/Windshield" mode.

Rear vents



The rear vents may be opened or closed as shown.

SECTION 2-2

AIR CONDITIONING AND AUDIO

Audio

Audio system	152
--------------------	-----

For vehicles equipped with Navigation System, please refer to the separate “Navigation System Owner’s Manual”.

AUDIO

AUDIO SYSTEM

Quick reference for your audio system



- You can adjust the brightness of the display. See "Instrument panel light control" on page 50 for details.
The "DISC" button works only when your Lexus is equipped with an automatic changer.
If a Mark Levinson brand audio system is installed, the "Mark Levinson" logo is shown on the panel.

1 Turning the system on and adjusting the volume

(See page 154 for details.)

2 Stopping and ejecting a cassette tape

(See page 161 for details.)

3 Function buttons**1 – 6:** Station selector buttons
(See page 158 for details.)**SCAN:** Scan tuning
(See page 159 for details.)**MSG:** Message button
(See page 160 for details.)**4 Display of functions in TAPE mode****◀▶:** Side change
(See page 162 for details.)**□□:** DOLBY NR
(See page 161 for details.)**◀◀:** Rewinding
(See page 162 for details.)**▶▶:** Fast forwarding
(See page 162 for details.)**RPT:** Automatic repeat
(See page 162 for details.)**SKIP:** Automatic skip of blank portions of tape
(See page 162 for details.)**4 Display of functions in CD mode****v Λ:** Disc selection
(See page 166 for details.)**◀◀:** Reversing
(See page 167 for details.)**▶▶:** Fast forwarding
(See page 167 for details.)**RPT:** Automatic repeat
(See page 168 for details.)**RAND:** Random access
(See page 168 for details.)**SCAN:** Track and disc scan selection
(See page 167 for details.)**5 AUDIO-TUNE knob**
(See page 155 for details.)**6 Radio data system/Traffic announcement/
Program type**
(See page 159 and 160 for details.)**7 Cassette tape slot**
(See page 161 for details.)**8 Mode selectors**
(See page 154 for details.)**9 Radio mode:** Seek tuning
(See page 158 for details.)**TAPE mode:** Direct access to a desired program
(See page 163 for details.)**CD mode:** Direct access to a desired program
(See page 167 for details.)

AUDIO

Using your audio system: some basics

This section describes some of the basic features of the Lexus audio system. Some information may not pertain to your system.

Your audio system works when the ignition key is in the "ACC" or "ON" position.

NOTICE

To prevent the battery from being discharged, do not leave the car audio on longer than necessary when the engine is not running.

(a) Turning the system on and off



Push this knob to turn the audio system on and off. Turn this knob to adjust the volume.

The system turns on in the last mode used.



Push "AM", "FM", "TAPE" or "DISC" to turn on that mode. The selected mode turns on directly.

Push these buttons if you want to switch from one mode to another.

If the tape or disc is not set, the cassette player or compact disc player does not turn on.

You can turn off the cassette player by ejecting the cassette tape. If the audio system was previously off, then the entire audio system will be turned off when you eject the cassette tape. If another function was previously playing, it will come on again.



In the "TAPE" or "CD" mode, the applicable functions are shown in the lowest part of the display. Push the switch just below to turn on each function.

(b) Tone and balance

How good an audio program sounds to you is largely determined by the mix of the treble, mid-range, and bass levels. In fact, different kinds of music and vocal programs usually sound better with different mixes of treble, mid-range, and bass.

A good balance of the left and right stereo channels and of the front and rear sound levels is also important.

Keep in mind that if you are listening to a stereo recording or broadcast, changing the right/left balance will increase the volume of one group of sounds while decreasing the volume of another.

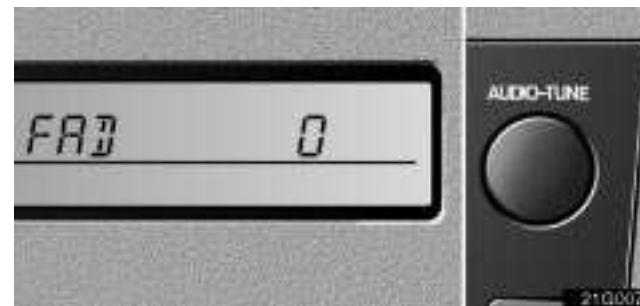

Each time you push the "AUDIO-TUNE" knob, the display changes as in the following. To adjust the tone and balance or turn on or off the automatic sound levelizer, turn the knob.

BAS: Adjusts low-pitched tones.

MID: Adjusts mid-pitched tones.

TRE: Adjusts high-pitched tones.

BAL: Adjusts the sound balance between the right and left speakers.

FAD: Adjusts the sound balance between the front and rear speakers.

ASL: Turns on or off the automatic sound levelizer.

Automatic sound levelizer: When the audio sound becomes difficult to be heard due to road noise, wind noise, etc. during driving, the system adjusts to the optimum volume and tone quality according to the noise level. While the automatic sound levelizer is on, "ASL" appears on the display.

AUDIO

(c) Your radio antenna

The wire antenna is mounted inside the rear window.

NOTICE

- *When cleaning the inside of the rear window, be careful not to scratch or damage the wire antenna.*
- *Putting a window tint (especially, conductive or metallic type) on the rear window may affect the reception of radio or mobile telephone. For the installation of the window tint, consult with your Lexus dealer.*

(d) Your cassette player

When you insert a cassette, the exposed tape should be to the right.

NOTICE

Do not oil any part of the cassette player, and do not insert anything except a cassette tape into the slot.

(e) Your changer



If your Lexus is equipped with a changer, it can play selected discs or continuously play all the discs set in the magazine.

When you set discs into the magazine, make sure they face the correct way. If not, the player will display "ERROR" and the disc number.

NOTICE

Never try to disassemble or oil any part of the compact disc player. Do not insert anything other than compact discs into the magazine.

The player is intended for use with 12 cm (4.7 in.) discs only.

Radio operation

(a) Listening to the radio



Push these buttons to choose either an AM or FM station.

"AM", "FM1", "FM2" or "FM TYPE" appear on the display.

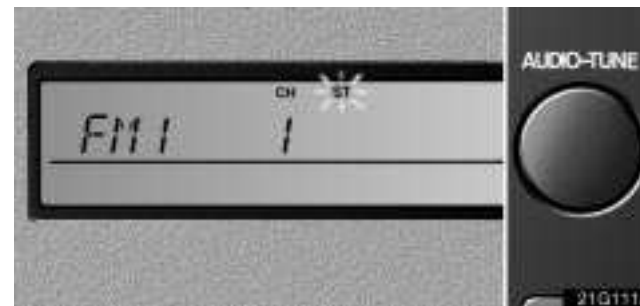

Turn this knob to the right to step up the station band or to the left to step down.

Your radio automatically changes to stereo reception when a stereo broadcast is received. "ST" appears on the display. If the signal becomes weak, the radio reduces the amount of channel separation to prevent the weak signal from creating noise. If the signal becomes extremely weak, the radio switches from stereo to mono reception. In this case, "ST" disappears from the display.

AUDIO

(b) Presetting a station



1. Tune in the desired station.
2. Push one of the station selector buttons (1–6) and hold it until a beep is heard. This sets the station to the button and the button number (1–6) appears on the display.

Each button can store one AM station and two FM stations. To change the preset station to a different one, follow the same procedure.

The preset station memory is cancelled when the power source is interrupted by battery disconnection or a blown fuse.

(c) Selecting a station

Tune in the desired station using one of the following methods.



Preset tuning: Push the button (1–6) for the station you want. The button number (1–6) and station frequency appear on the display.

Manual tuning: Turn the “AUDIO-TUNE” knob. The radio will step up or down to another frequency.

Seek tuning: Push the “SEEK” button. The radio will begin seeking up or down for a station of the nearest frequency and will stop on reception. Each time you push the button, the stations will be searched automatically one after another.



To scan all the frequencies: Push the "SCAN" button. "SCAN" appears on the display. The radio will find the next station up the band, stay there for a few seconds, and then scan again. To select a station, push the "SCAN" button a second time.

To scan the preset stations: Push the "SCAN" button until you hear a beep. "P.SCAN" appears on the display. The radio will tune in the next preset station up the band, stay there for a few seconds, and then move to the next preset station. To select a station, push the "SCAN" button a second time.

(d) RDS (Radio Data System)



When you push the "RDS" button briefly during FM reception, the RDS turns on. "RDS" and "RDS SEARCH" appear on the display and the radio starts to search RDS stations.

If no RDS stations can be found, "NOTHING" appears and the display returns to the previous mode.

If RDS stations are found, "FOUND **ST" appears on the display (** indicating the number of stations which are found) in the FM TYPE mode and the RDS stations are preset by program type.

To turn off the RDS, push the "RDS" button until you hear a beep.

AUDIO

TYPE (Program type):

When you push the "TYPE" button while receiving an RDS station, the current program type appears on the display.

Each time you push the "TYPE" button, the program type changes as in the following:

- ROCK
- EASY LIS (Easy listening)
- CLS/JAZZ (Classical music and jazz)
- R&B (Rhythm and Blues)
- INFORM (Information)
- RELIGION
- MISC
- ALERT (Emergency message)

TRAF (Traffic) function: A station that regularly broadcasts traffic information is automatically located.

When you push the "TRAF" button, "TRAF SEEK" appears on the display and the radio will start seeking any traffic program station.

If no traffic program station is found, "NO TRAF INFO" appears on the display for a few seconds and the display returns to the previous mode.

Radio text message:



If the radio receives a radio text message during FM reception, "MSG" and a text message appears on the display. After the text message goes off, "MSG" also goes off.

After the text message goes off from the display, pushing the "MSG" button during message reception shows the text message again on the display.

The RDS audio system can store three messages consisting of 64 characters in memory. To store a message in memory, push the "MSG" button until you hear a beep.

If three messages are already stored in memory, the oldest message will be overwritten by the new message.

To recall a radio text message, push the "MSG" button. Each time you push the button, the available message will be displayed beginning with the newest one.

If there is no radio text message in memory and when no message is received, "NO MSG STORED" appears on the display. After this, the display returns to the previous mode.

Cassette tape player operation

(a) Playing a cassette tape



When you insert a cassette tape, the exposed tape should face to the right.

The player will automatically start when you insert a cassette tape. At this time, "TAPE" appears on the display.

If a metal or chrome equivalent cassette tape is put in the cassette player, the player will automatically recognize it and "METAL" appears on the display.

To stop or eject the cassette tape, push the "EJECT" button.

Auto-reverse feature: After the cassette player reaches the end of a tape, it automatically reverses and begins to play the other side, regardless of whether the cassette was playing or fast forwarding.



If a cassette is already in the slot, push the "TAPE" button.

Dolby® Noise Reduction* feature: If you are listening to a tape that was recorded with Dolby* Noise Reduction, push the button by the double-D symbol. The display will indicate that the Dolby noise reduction system is on.

The Dolby NR mode reduces tape noise by about 10 dB. For best sound reproduction, play your tapes with the Dolby NR on or off according to the mode used for recording the tape.

To play a tape recorded without Dolby NR, push the button again to turn off the Dolby NR.

* Dolby noise reduction manufactured under license from Dolby Laboratories Licensing Corporation. "DOLBY" and the double-D symbol  are trademarks of Dolby Laboratories Licensing Corporation.

AUDIO

(b) Manual program selection



"Program" button: Push the "◀▶" button to select the other side of a cassette tape. The display indicates which side is currently selected (▲ indicates top side, ▼ indicates bottom side).

"Rewind" button: Push the "◀◀" button to rewind a tape. "REW" appears on the display.

To stop rewinding, push the same button or "TAPE" button.

"Fast forward" button: Push the "▶▶" button to fast forward a cassette tape. "FF" appears on the display.

To stop fast forwarding, push the same button or "TAPE" button.

(c) Automatic program selection



"RPT" button: The repeat feature automatically replays the current program.

Push the "RPT" button while the program is playing. When the program ends, it will automatically be rewound and replayed. Push the button again to turn off the repeat feature.

There must be at least 4 seconds of blank space between programs for the repeat feature to work correctly.

"SKIP" button: The skip feature allows you to fast forward past long stretches of blank tape. This is especially useful at the end of cassettes.

Push the "SKIP" button. The player will automatically skip any blank portions of 15 seconds or more and play the next program. To cancel it, push the button once again.



"Automatic program selection" button: The automatic program selection feature allows you to program your cassette player to skip forward or backward to locate the song you want to hear. You can skip up to 9 programs at a time.

Push this button on the upper side to skip forward. "FF" and the number will appear on the display. Push the button until the number you want to skip appears on the display. After that, the player will automatically skip forward.

When the end of the tape is reached, the player automatically reverses sides and resumes normal play.

Push this button on the lower side to skip backward. Push the button until "REW" and the number you want to skip appear on the display.

- If you set "REW 1", the player will rewind to the beginning of the current program.
- When counting the number of programs you want to rewind, remember to count the current program as well. For example, if you want to rewind to a song that is two before the song you are listening to, push this button until "REW 3" appears on the display.

When the beginning of the tape is reached, the player automatically resumes normal play.

There must be at least 3 seconds of blank space between programs for this feature to work correctly.

"RPT", "SKIP" or "Automatic program selection" features: These features may not work well with some spoken word, live or classical recordings.

AUDIO

Compact disc player operation

The compact disc player is an optional accessory that your vehicle is pre-wired to accept. Although your audio system has a DISC button, your vehicle may or may not be equipped with a CD player. Please contact your dealer for additional details if you would like to have the optional CD player installed.

(a) Inserting compact discs



1. Pull the lever and open the glove box door.



2. Slide and open the cover.

The magazine is automatically ejected.



3. Pull out the tray while pushing the lock release button.



4. Put a disc on the tray with its label face up and push the tray back into the magazine.

If the label faces down, the disc cannot be played. In this case, "ERROR" and the disc number appears on the display.

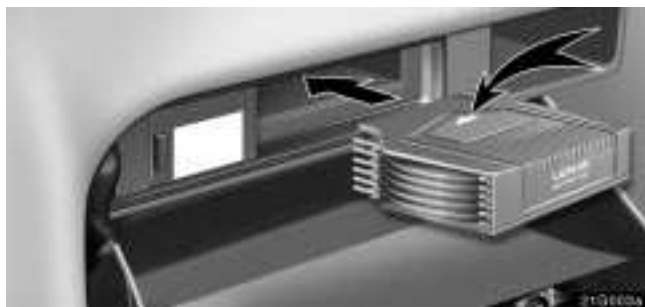

5. Insert the magazine into the player as indicated by the arrow head on the magazine, and close the cover and glove box door.

When the magazine is set completely, the system will be in a "Load" cycle for approximately 10 seconds while the system searches for discs in the magazine. Upon completion of this cycle, the CD unit will be ready to play. If the "DISC" button is pushed during the "Load" cycle, "LOAD" appears on the display until the system has completed the load cycle, after which the system will begin normal play.

⚠ CAUTION

To reduce the chance of injury in case of an accident or a sudden stop, always keep the glove box door closed while driving.

AUDIO

(b) Playing a compact disc



Push the "DISC" button if the magazine is already loaded in the player.

"CD" appears on the display.

The discs set in the magazine are played continuously, starting with disc number 1. The disc number of the disc currently being played, the track number and the time from the beginning of the program appear on the display.

When play of one disc ends, the first track of the following disc starts. When play of the final disc ends, play of the first disc starts again.

The player will skip any empty disc trays.

(c) Selecting a desired disc



Push the "v" or "Λ" button to select the disc number.

Push the button several times until the desired disc number appears on the display. When you release the button, the player will start playing the selected disc from the first track.

(d) Selecting a desired track

"TRACK" button: Use for direct access to a desired track.

Push either side of the "TRACK" button several times until the desired track number appears on the display. As you release the button, the player will start playing the selected track from the beginning.

"Fast forward" button.

Push the "▶▶" button and hold it to fast forward the disc. When you release the button, the compact disc player will resume playing from that position.

"Reverse" button.

Push the "◀◀" button and hold it to reverse the disc. When you release the button, the compact disc player will resume playing.

(e) Searching for a desired track or disc**Searching for a desired track:**

Push the "SCAN" button briefly. "SCAN" will appear on the display. The compact disc player will play the next track for 10 seconds, then scan again. To select a track, push the "SCAN" button a second time. If the player reaches the end of the disc, it will continue scanning at track 1.

After all the tracks or discs in the magazine are scanned in one pass, normal play resumes.

Searching for a desired disc:

Push the "SCAN" button until you hear a beep. With "D.SCAN" on the display, the program at the beginning of each disc will be played for 10 seconds. To continue listening to the program of your choice, push the button a second time.

After all the discs in the magazine are scanned in one pass, the scan function is cancelled.

AUDIO

(f) Other compact disc player functions



"RPT" button: Use it for automatic repeat of the track or disc you are currently listening to.

Push the button briefly while the track is playing. "RPT" appears on the display. When the track is finished, the player will automatically go back to the beginning of the track and play the track again. To cancel it, push the button once again.

Push the button until you hear a beep. "D.RPT" appears on the display. When the disc is finished, the player will automatically go back to the first track of the disc and play again.

To cancel it, push the button once again.

"RAND" button: Use it for automatic track or disc selection and play by the system.

When the button is pushed briefly, "RAND" appears on the display. The system selects a track in the discs which are set and plays it. To cancel it, push the button once again.

When the button is pushed until you hear a beep, "D.RAND" appears on the display. The system selects a track and discs in the magazine which are set and plays it. To cancel it, push the button once again.

When a track is skipped or the system is inoperative, push the button to reset.

(g) If the player malfunctions

If "WAIT" appears on the display, audio signals of the disc cannot be read or the system has trouble. Push the "DISC" button once again.

If the player does not operate, check that the disc surface is not soiled or damaged. If the disc is O.K., the following two causes are possible.

- Condensation may have occurred on the internal mechanism of the changer. Open the cover to let the air circulate.
- The temperature of the player's internal mechanism is raised because of high external temperature. Remove the magazine from the player to cool it.

If the player still does not operate, take it to your Lexus dealer.

Steering pad switches (GS430 only)

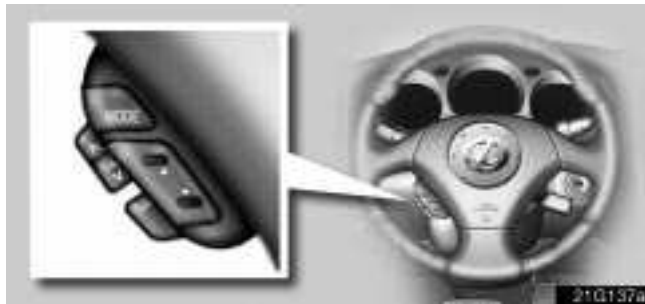

The steering pad switches are installed on the left side of the steering wheel.

“MODE” switch: Push the “MODE” switch to select an audio mode. Each push changes the mode sequentially if the desired mode is ready to use. When you push the switch with the audio system turned off, the audio system turns on.

“VOL” switches: Push “**▲**” to increase the volume and “**▼**” to decrease the volume. The volume continues to increase or decrease while the switch is being pressed.

“SET” switch: Push the “SET” switch to change to the preset volume. To preset the volume, adjust the volume and push the switch until you hear a beep.

“▼” or “▲” switch: The function in each mode is shown below.

(a) When the radio mode is selected

- Push this switch briefly to select a station that you assigned to a switch on the audio system.
- Push this switch and hold it until you hear a beep. The radio will begin seeking up or down for a station and stop on reception.

(b) When the “TAPE” mode is selected

- Push this switch briefly for automatic program selection. In automatic program selection, you can skip up to 9 programs at a time. For details, see page 162 for details.
- Push this switch until you hear a beep to fast forward or rewind the tape. To stop fast forwarding or rewinding, push the same side on the switch.

(c) When the “CD” mode is selected

- Push this switch briefly to select a desired track.
- To select a desired disc, push and hold this switch until you hear a beep.



CAUTION

Operate the steering pad switches with due care while you are driving to avoid accidents.

AUDIO

Car audio system operating hints

NOTICE

To ensure correct audio system operations:

- *Be careful not to spill beverages over the audio system.*
- *Do not put anything other than a cassette tape or CD magazine into the cassette tape slot or CD changer.*
- *The use of a cellular phone inside or near the vehicle may cause a noise from the speakers of the audio system which you are listening to. However, this does not indicate a malfunction.*

Radio reception

Usually, a problem with radio reception does not mean there is a problem with your radio – it is just the normal result of conditions outside the vehicle.

For example, nearby buildings and terrain can interfere with FM reception. Power lines or telephone wires can interfere with AM signals. And of course, radio signals have a limited range. The farther you are from a station, the weaker its signal will be. In addition, reception conditions change constantly as your vehicle moves.

Here are some common reception problems that probably do not indicate a problem with your radio:

FM

Fading and drifting stations – Generally, the effective range of FM is about 40 km (25 miles). Once outside this range, you may notice fading and drifting, which increase with the distance from the radio transmitter. They are often accompanied by distortion.

Multi-path – FM signals are reflective, making it possible for two signals to reach your antenna at the same time. If this happens, the signals will cancel each other out, causing a momentary flutter or loss of reception.

Static and fluttering – These occur when signals are blocked by buildings, trees, or other large objects. Increasing the bass level may reduce static and fluttering.

Station swapping – If the FM signal you are listening to is interrupted or weakened, and there is another strong station nearby on the FM band, your radio may tune in the second station until the original signal can be picked up again.

AM

Fading – AM broadcasts are reflected by the upper atmosphere – especially at night. These reflected signals can interfere with those received directly from the radio station, causing the radio station to sound alternately strong and weak.

Station interference – When a reflected signal and a signal received directly from a radio station are very nearly the same frequency, they can interfere with each other, making it difficult to hear the broadcast.

Static – AM is easily affected by external sources of electrical noise, such as high tension power lines, lightening, or electrical motors. This results in static.

Caring for your cassette player and tapes

For the best performance for your cassette player and tapes:

Clean the tape head and other parts regularly.

- A dirty tape head or tape path can decrease sound quality and tangle your cassette tapes. The easiest way to clean them is by using a cleaning tape. (A wet type is recommended.)

Use high-quality cassettes:

- Low-quality cassette tapes can cause many problems, including poor sound, inconsistent playing speed, and constant auto-reversing. They can also get stuck or tangled in the cassette player.
- Do not use a cassette if it has been damaged or tangled or if its label is peeling off.
- Do not leave a cassette in the player if you are not listening to it, especially if it is hot outside.
- Store cassettes in their cases and out of direct sunlight.
- Avoid using cassettes with a total playing time longer than 100 minutes (50 minutes per side). The tape used in these cassettes is thin and could get stuck or tangled in the cassette player.

AUDIO

Caring for your compact disc player and discs

- Your compact disc player is intended for use with 12 cm (4.7 in.) discs only.
- Extremely high temperature can keep your compact disc player from working. On hot days, use air conditioning to cool the vehicle interior before you listen to a disc.
- Bumpy roads or other vibrations may make your compact disc player skip.
- If moisture gets into your compact disc player, you may not hear any sound even though your compact disc player appears to be working. Eject all discs from the player and wait until the player dries.



CAUTION

Compact disc players use an invisible laser beam which could cause hazardous radiation exposure if directed outside the unit. Be sure to operate the player correctly.



- Use only compact discs marked as shown above. The following products may not be playable on your compact disc player.

Copy-protected CD
CD-R (CD-Recordable)
CD-RW (CD-Re-writable)
CD-ROM



► *Special shaped discs*

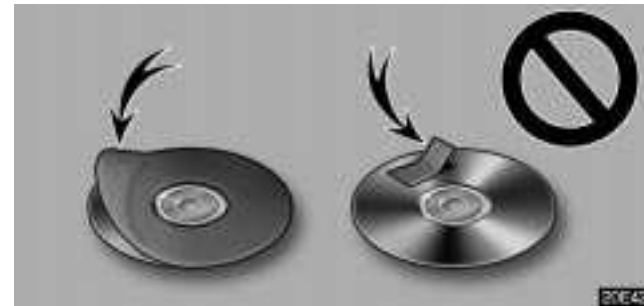

► *Labeled discs*

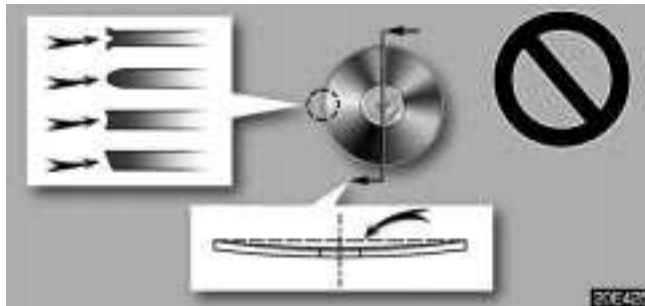

► *Low quality discs*

NOTICE

To prevent damage to the player or changer, do not use special shaped, low quality or labeled discs such as those shown in the illustrations.

AUDIO



► **Correct**

► **Wrong**

- Handle compact discs carefully, especially when you set them into the player. Hold them on the edge and do not bend them. Avoid getting fingerprints on them, particularly on the shiny side.
- Dirt, scrapes, warping, pin holes, or other disc damage could cause the player to skip or to repeat a section of a track. (To see a pin hole, hold the disc up to the light.)



To clean a compact disc: Wipe it with a soft, lint-free cloth that has been dampened with water. Wipe in a straight line from the center to the edge of the disc (not in a circle). Do not use a conventional record cleaner or anti-static device.

SECTION 3-1

STARTING AND DRIVING

Starting and driving

Three-way catalytic converters	176
Engine exhaust caution	177
Before starting the engine	178
Ignition switch with steering lock	178
Parking brake	179
How to start the engine	180
Automatic transmission	181
Electronic throttle control system	189
Cruise control	190
Traction control system	193
Vehicle stability control system	194
Brake system	196
Brake pad wear limit indicators	200
Types of tires	201

THREE-WAY CATALYTIC CONVERTERS



► GS430



► GS300

Three-way catalytic converters are emission control devices installed in the exhaust system.

The purpose is to reduce pollutants in the exhaust gas.

CAUTION

- Keep people and combustible materials away from the exhaust pipe while the engine is running. The exhaust gas is very hot.
- Do not drive, idle or park your vehicle over anything that might burn easily such as grass, leaves, paper or rags.

NOTICE

A large amount of unburned gases flowing into the three-way catalytic converter may cause it to overheat and create a fire hazard. To prevent this and other damage, observe the following precautions:

- Use only unleaded gasoline.
- Do not drive with an extremely low fuel level; running out of fuel could cause the engine to misfire, creating an excessive load on the three-way catalytic converter.
- Do not allow the engine to run at idle speed for more than 20 minutes.

- *Avoid racing the engine.*
- *Do not push-start or pull-start your vehicle.*
- *Do not turn off the ignition while the vehicle is moving.*
- *Keep your engine in good running order. Malfunctions in the engine electrical system, electronic ignition system or fuel system could cause an extremely high three-way catalytic converter temperature.*
- *If the engine becomes difficult to start or stalls frequently, take your vehicle in for a check-up as soon as possible. Remember, your Lexus dealer knows your vehicle and its three-way catalytic converter system best.*
- *To ensure that the three-way catalytic converter and the entire emission control system operate properly, your vehicle must receive the periodic inspections required by the Lexus Maintenance Schedule. For scheduled maintenance information, refer to the "Owner's Manual Supplement / Scheduled Maintenance".*

ENGINE EXHAUST CAUTION



- Avoid inhaling the engine exhaust. It contains carbon monoxide, which is a colorless and odorless gas. It can cause unconsciousness or even death.
- Make sure the exhaust system has no holes or loose connections. The system should be checked from time to time. If you hit something, or notice a change in the sound of the exhaust, have the system checked immediately.
- Do not run the engine in a garage or enclosed area except for the time needed to drive the vehicle in or out. The exhaust gases cannot escape, making this a particularly dangerous situation.
- Do not remain for a long time in a parked vehicle with the engine running. If it is unavoidable, however, do so only in an unconfined area and adjust the heating or cooling system to force outside air into the vehicle.
- Keep the trunk lid closed while driving. An open or unsealed trunk lid may cause exhaust gases to be drawn into the vehicle.

STARTING AND DRIVING

- To allow proper operation of your vehicle's ventilation system, keep the inlet grilles in front of the windshield clear of snow, leaves, or other obstructions.
- If you smell exhaust fumes in the vehicle, drive with the windows open and the trunk lid closed. Have the cause immediately located and corrected.

BEFORE STARTING THE ENGINE

1. Check the area around the vehicle before entering it.
2. Adjust seat position, seatback angle, head restraint height and steering wheel angle.
3. Adjust the inside and outside rear view mirrors.
4. Lock all doors.
5. Fasten seat belts.

Remember to check that the service reminder indicators function when turning the key to "ON", and check the fuel gauge to see that you have sufficient fuel.

IGNITION SWITCH WITH STEERING LOCK



"START" – Starter motor on. The key will return to the **"ON"** position when released.

For starting tips, see page 180.

"ON" – Engine on and all accessories on.

This is the normal driving position.

NOTICE

Do not leave the key in the "ON" position if the engine is not running. The battery will discharge and the electronic ignition system could be damaged.

"ACC" – Accessories such as the radio operate, but the engine is off.

If you leave the key in the "ACC" or "LOCK" position and open the driver's door, a buzzer will remind you to remove the key.*

*NOTE: *The volume or interval of beep sound can be changed. Ask your Lexus dealer for details.*



"LOCK" – Engine is off and the steering wheel is locked. The ignition key can be removed only at this position.

To turn the key from "ACC" to the "LOCK" position, you must put the transmission selector lever in the "P" position.

Once you remove the key, the engine immobiliser system is automatically set. See "Engine immobiliser system" on page 11.

When starting the engine, the key may seem stuck at the "LOCK" position. To free it, first be sure the key is pushed all the way in, and then rock the steering wheel slightly while turning the key gently.

If, in an emergency, you must turn the engine off while the vehicle is moving, turn the key only to "ACC".

PARKING BRAKE

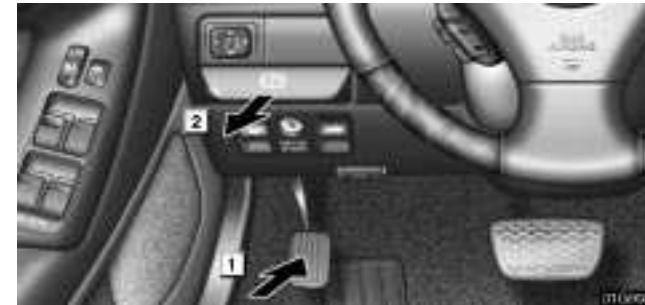

- 1 To set: Fully depress the parking brake pedal.**
- 2 To release: Pull the parking brake release lever.**

Before leaving your vehicle, firmly apply the parking brake.



CAUTION

Before driving, make sure the parking brake is fully released and that the parking brake reminder light is off.

STARTING AND DRIVING

HOW TO START THE ENGINE

Before cranking

1. Apply the parking brake firmly.
2. Turn off unnecessary lights and accessories.
3. Put the selector lever in "P". If you need to restart the engine while the vehicle is moving, put the selector lever in "N". A starter safety device will prevent the starter from operating if the selector lever is in any drive position.
4. Depress the brake pedal and hold it to the floor until driving off.

Starting the engine

Before starting the engine, be sure to follow the instructions in "Before cranking".

Normal starting procedure

The multiport fuel injection system/sequential multiport fuel injection system in your engine automatically controls the proper air–fuel mixture for starting. You can start a cold or hot engine as follows:

With your foot off the accelerator pedal, crank the engine by turning the ignition switch to "START". Release it when the engine starts.

Engine should be warmed up by driving, not in idle. For warming up drive with smoothly turning engine until engine coolant temperature is within normal range.

If the engine stalls ...

Simply restart it , using the correct procedure given in normal starting.

If the engine will not start

See "If your vehicle will not start" on page 212.

NOTICE

- ***Do not crank for more than 30 seconds at a time. This may overheat the starter and wiring systems.***
- ***Do not race a cold engine.***
- ***If the engine becomes difficult to start or stalls frequently, have the engine checked immediately.***

AUTOMATIC TRANSMISSION

Your automatic transmission has a shift lock system to minimize the possibility of incorrect operation. This means you can only shift out of "P" position when the brake pedal is depressed with the ignition switch in "ON" position. (★)



► *The shift position is displayed on the instrument cluster.*

GS430:

P: Parking, engine starting and key removal

R: Reverse

N: Neutral

D: Normal driving (with overdrive on)

4: Engine braking

When the cruise control is being used, even if you downshift from "D" to "4", engine braking will not be enabled because the cruise control is not cancelled. For the operation to decrease the vehicle speed, see page 192.

3, 2: Stronger engine braking

L: Maximum engine braking

STARTING AND DRIVING

GS300:

P: Parking, engine starting and key removal

R: Reverse

N: Neutral

D: Normal driving (with overdrive on)

M: Manual shifting up or downshifting

When the cruise control is being used, even if you downshift from "D" to "4", engine braking will not be enabled because the cruise control is not cancelled. For the operation to decrease the vehicle speed, see page 192.

3, 2: Stronger engine braking

L: Maximum engine braking

Correct use of the automatic transmission is explained in the following parts.

- (a) Normal driving
- (b) Driving in M mode (GS300 only)
- (c) Using engine braking
- (d) Using the "3", "2" and "L" positions
- (e) Backing up
- (f) Parking
- (g) Good driving practice
- (h) If you cannot shift the selector lever

(a) Normal driving



▶ **1** "P" (Park) position **2** "N" (Neutral) position

1. Start the engine as instructed in "How to start the engine" on page 180.

The transmission must be in "P" or "N". The engine will not start in any drive position even if the ignition key is turned to "START".

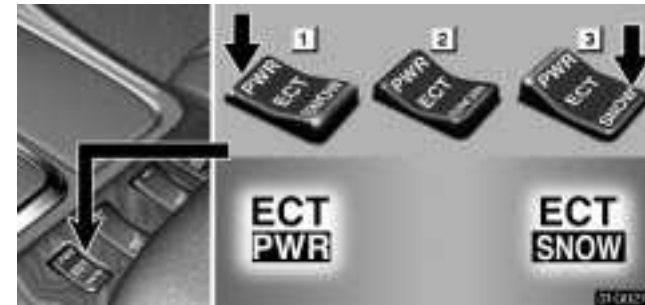

▶ **1** Power position **2** Normal position
3 Snow position

2. Set the driving pattern selector switch to the "Normal" position.

Your transmission has a driving pattern selector switch which allows you to select "Power", "Normal" or "Snow" mode to suit your driving condition. For ordinary driving, Lexus recommends that you use the "Normal" position to improve fuel economy.

3. For more powerful acceleration and sporty driving, use the "Power" position.

In the "Power" position, the "ECT PWR" light in the instrument cluster is on and the transmission is shifted up at higher vehicle speeds and shifted down more responsively than in the "Normal" position.

For "Snow" mode, see "Electronic Throttle Control System" on page 189.

STARTING AND DRIVING



► **1** Brake pedal **2** "D" (Drive) position

4. With your foot holding down the brake pedal, shift the selector lever to "D".

Always use the "D" position to improve fuel economy and quiet driving. Only in this position, shifting into the overdrive gear is possible. However, while the engine coolant temperature is low, the transmission will not shift into the overdrive gear even in the "D" position. (See "(c) Using engine braking" and "(g) Good driving practice" for exceptions.)

CAUTION

Never put your foot on the accelerator pedal while shifting.

5. Release the parking brake and brake pedal. Depress the accelerator pedal slowly for smooth starting.

In normal cruising, the vehicle will start in first gear and automatically shift up to the most suitable gear. On inclines, declines or winding roads, etc., the vehicle shifts up and down automatically according to the running conditions to obtain the suitable driving power and engine braking.

When the lever is in "4" position, the automatic transmission system will select the most suitable gear for the running conditions such as hill climbing, hard towing, etc.

If you need to accelerate rapidly while driving, depress the accelerator pedal to the full throttle position. This provides more acceleration by automatically downshifting the transmission to the next lower gear or beyond, depending on the vehicle speed.

If engine braking is needed, such as in descending a long hill, see "(c) Using engine braking".

(b) Driving in M mode (GS300 only)



► **1 "M" position** **2 Downshifting on the front, Upshifting on the rear**

When the selector lever is put in the "M" position, the "M" indicator is shown on the instrument cluster. Pushing either of the switches on the front or rear of the steering wheel downshifts the transmission from "D" to "2" position or upshifts from "2" to "D" position.

The current gear position is displayed on the instrument cluster.

Each time you push the switch located on the front of the steering wheel, the transmission downshifts (from "D") to "4", "3" and then "2".

When you push the switch located on the back of the steering wheel, the transmission upshifts to "3", "4" and then "D".

For the precautions on each position, see the description on the previous page.

2 warning tones sound in the following case:

- You attempt to downshift the transmission when it is not possible to downshift due to the high vehicle speed.

If the "M" indicator flashes, there is a problem somewhere in the system. In this case, it should be noted that you cannot downshift or upshift the transmission using the switches on the steering wheel. Consult with your Lexus dealer as soon as possible. The transmission works exactly in the same way as when you put the selector lever in the "D" position.

 CAUTION
<p>Be careful when downshifting on a slippery surface. The abrupt change in engine speed could cause the vehicle to spin or skid.</p>

STARTING AND DRIVING

(c) Using engine braking



To use the braking power of the engine, downshift the transmission in the way described below:

- 1 Shift into the "4" position. The transmission will downshift to fourth gear and engine braking will be enabled.

When the cruise control is being used, even if you downshift from "D" to "4", engine braking will not be enabled because the cruise control is not cancelled. If you need to decrease the vehicle speed, see page 192.

- 2 Shift into the "3" position. The transmission will downshift to third gear when the vehicle speed is or becomes lower than the speed listed below and stronger engine braking will be enabled.

- 3 Shift into the "2" position. The transmission will downshift to second gear when the vehicle speed is or becomes lower than the speed listed below and more powerful engine braking than that of "3" position will be enabled.
- 4 Shift into the "L" position. The transmission will downshift to first gear when the vehicle speed is or becomes lower than the speed listed below and maximum engine braking will be enabled.

	GS430 km/h (mph)	GS300 km/h (mph)
"3"	153 (95)	128 (80)
"2"	100 (62)	85 (53)
"L"	39 (24)	16 (10)

CAUTION

Be careful when downshifting on a slippery surface. The abrupt change in engine speed could cause the vehicle to spin or skid.

(d) Using the "3", "2" and "L" positions

The "3", "2" and "L" positions are used for strong engine braking as described previously.

With the selector lever in "3", "2" or "L", you can start the vehicle in motion as with the lever in "D".

With the selector lever in "3" or "2", the vehicle will start in first gear and automatically shift to third or second gear.

With the selector lever in "L", the transmission is engaged in first gear.

NOTICE		
<ul style="list-style-type: none"> Be careful not to over-rev the engine. Watch the tachometer to keep engine rpm from going into the red zone. The approximate maximum allowable speed for each position is given below for your reference: 		
	GS430	GS300
	<i>km/h (mph)</i>	<i>km/h (mph)</i>
"3"	156 (97)	130 (81)
"2"	102 (63)	85 (53)
"L"	66 (41)	55 (34)
<ul style="list-style-type: none"> Do not continue hill climbing or hard towing for a long time in the "3", "2" or "L" position. This may cause severe automatic transmission damage from overheating. To prevent such damage, "4" position should be used in hill climbing or hard towing. 		

(e) Backing up



► **1** Brake pedal **2** "R" (Reverse) position

1. Bring the vehicle to a complete stop.
2. With the brake pedal held down with your foot, shift the selector lever to the "R" position.

NOTICE
Never shift into reverse while the vehicle is moving.

STARTING AND DRIVING

(f) Parking



- **1** Brake pedal **2** Parking brake pedal
3 "P" (Park) position

1. Bring the vehicle to a complete stop.
2. Depress the parking brake pedal fully.
3. With the brake pedal held down with your foot, shift the selector lever to the "P" position.

CAUTION

Never attempt to move the selector lever into "P" under any circumstances while the vehicle is moving. Serious mechanical damage and loss of vehicle control may result.

(g) Good driving practice

If the transmission repeatedly shifts up and down between the fourth and overdrive gears when climbing a gentle slope, shift the selector lever to the "4" position. Be sure to shift the selector lever to the "D" position after climbing the slope.

CAUTION

Always keep your foot on the brake pedal while stopped with the engine running. This prevents the vehicle from creeping.

NOTICE

Always use the brake pedal or the parking brake to hold the vehicle on an upgrade. Do not attempt to hold the vehicle using the accelerator pedal, as this can cause the transmission to overheat.

(h) If you cannot shift the selector

If you cannot shift the selector lever even though the brake pedal is depressed, use the shift lock override button. For instructions, see "If you cannot shift automatic transmission selector lever" on page 230.

ELECTRONIC THROTTLE CONTROL SYSTEM

The electronic throttle control system always maintains appropriate engine output in relation to the accelerator opening in all driving conditions.

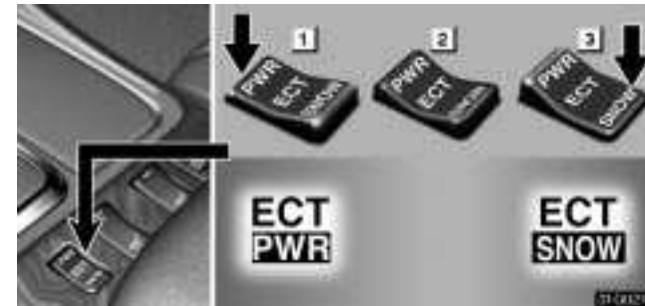

- ▶ **1** Power position **2** Normal position
- 3** Snow position

The electronic throttle control system has 3 modes: Normal, Power and Snow modes.

Normal mode: For ordinary driving, Lexus recommends that you use the normal mode to improve fuel economy.

Power mode: For more powerful acceleration and sporty driving.

STARTING AND DRIVING

In the power mode, the "ECT PWR" light in the instrument cluster is on and the transmission is shifted up at higher vehicle speeds and shifted down more responsively than in the normal mode.

To return to the normal mode, push the driving pattern selector switch lightly on the "SNOW" side.

Snow mode: For slippery road surfaces such as in snow. In this mode, the spinning of the rear wheels is controlled appropriately.

When you push the driving pattern selector switch on the "SNOW" side, the snow mode is turned on and the "ECT SNOW" light in the instrument cluster comes on.

To return to the normal mode, push the driving pattern selector switch on the "SNOW" side again.

When you turn the ignition switch off in the snow mode, the mode automatically changes to the normal mode.

CRUISE CONTROL

The cruise control allows you to cruise the vehicle at a desired speed over 40 km/h (25 mph) with your foot off the accelerator pedal.

Your cruising speed can be maintained although a slight speed change may occur when driving up or down a gradient, within the limits of engine performance. On steeper hills, a great speed change will occur so it is better to drive without the cruise control.

When the cruise control is on, the driving pattern of the automatic transmission is fixed in the normal position, regardless of the position of the selector switch.

CAUTION

- **To help maintain maximum control of your vehicle, do not use the cruise control when driving in heavy or varying traffic, or on slippery (rainy, icy or snow-covered) or winding roads.**
- **Avoid vehicle speed increases when driving downhill. If the vehicle speed is too fast in relation to the cruise control set speed, cancel the cruise control then downshift the transmission to use engine braking to slow down.**

Turning the system on

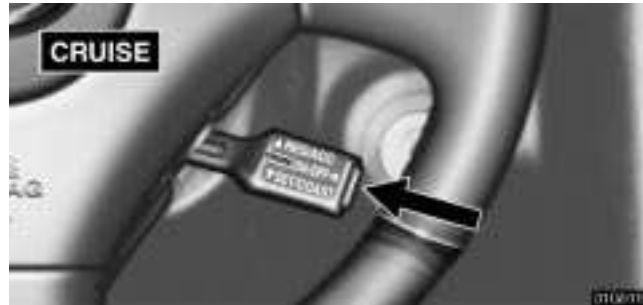

To operate the cruise control, push the main switch. This turns the system on. The indicator light in the instrument cluster shows that you can now set your desired cruising speed. Another push on the switch will turn the system completely off.

When the ignition key is turned off, the main switch is also automatically turned off. To use the cruise control again, push the main switch again to turn it on.

⚠ CAUTION

To avoid accidental cruise control engagement, keep the main switch off when not using the cruise control.

Setting operation



► *Each function is described below.*

1 Setting at a desired speed.

The transmission must be in "D" or "4" before you set the cruise control speed.

Bring the vehicle to the desired speed, press the control lever downward in the "SET/COAST" direction and release it. This sets the vehicle at that speed. Now you may take your foot off the accelerator pedal. If you need acceleration – for example, when passing – depress the accelerator pedal enough for the vehicle to exceed the set speed. When you release the accelerator pedal, the vehicle will return to the speed set prior to the acceleration.

STARTING AND DRIVING

2 Cancelling the preset speed

You can cancel the preset speed by either of the following:

- a. Pulling the control lever in the "CANCEL" direction.
- b. Depressing the brake pedal.

If the vehicle speed falls below about 40 km/h (25 mph), the preset speed will be automatically cancelled.

If the vehicle speed drops 16 km/h (10 mph) below the preset speed, the preset speed will also automatically be cancelled.

If the preset speed automatically cancels out for other than these reasons, have your vehicle checked by your Lexus dealer at the earliest opportunity.

3 Resetting to a faster speed

Press the control lever upward in the "RES/ACC" direction and hold it. Release the lever when the desired speed is attained. While the lever is held upward, the vehicle will gradually gain speed.

When the difference between the actual vehicle speed and the set speed is less than 5 km/h (3 mph), the set speed can be increased 1.6 km/h (1 mph) each time by pressing the control lever upward in the "RES/ACC" direction quickly within 0.6 seconds.

However, a quicker way to reset is to accelerate the vehicle and then press the control lever downward in the "SET/COAST" direction.

4 Resetting to a slower speed

Press the control lever downward in the "SET/COAST" direction and hold it. Release the lever when the desired speed is attained. While the lever is held downward, the vehicle speed will gradually decrease.

When the difference between the actual vehicle speed and the set speed is less than 5 km/h (3 mph), the set speed can be lowered 1.6 km/h (1 mph) each time by pressing the control lever downward in the "SET/COAST" direction quickly within 0.6 seconds.

However, a quicker way to reset is to depress the brake pedal and then press the control lever downward in the "SET/COAST" direction.

Even if you downshift the transmission from the "D" position to "4" with the cruise control on, engine braking will not be applied because the cruise control is not cancelled. To decrease the vehicle speed, reset to a slower speed with the cruise control lever or depress the brake pedal. If you use the brake pedal, cruise control is cancelled.

5 Resuming the preset speed

If the preset speed is cancelled by pulling the control lever or by depressing the brake pedal, pushing the lever up in the "RES/ACC" direction will restore the speed set prior to cancellation. However, once the vehicle speed falls below about 40 km/h (25 mph), the preset speed will not be resumed.

Cruise control failure warning

If the "CRUISE" indicator light in the instrument cluster flashes five times and then goes out when using the cruise control, it means that there is trouble in the cruise control system. Contact your Lexus dealer.

TRACTION CONTROL SYSTEM

The traction control system automatically helps control the spinning of the rear wheels which may occur when accelerating on slippery road surfaces, thus assisting driver to control the driving power of the rear wheels.



► Slip indicator light

When you turn the ignition switch on, this system always turns on. Leave the system on during ordinary driving so that it can operate when needed. When traction control is applied, the slip indicator light blinks.

You may hear a sound in the engine compartment for a few seconds when the engine is started or just after the vehicle begins to move. This means that the traction control system is in the self-check mode, and does not indicate malfunction.

When the traction control system is operating, you may feel vibration of your vehicle, caused by operation of the brakes. This indicates the system is functioning properly.

STARTING AND DRIVING

When getting the vehicle out of mud or new snow, etc. the traction control system will help operate to prevent the wheels from spinning.

To turn off the traction control system, see page 195.



CAUTION

Under certain slippery road conditions, full traction of the vehicle and power to the rear wheels cannot be maintained, even though the traction control system is in operation. Do not drive the vehicle under any speed or maneuvering conditions which will cause the vehicle to lose traction. In situations where the road surface is covered with ice or snow, your vehicle should be fitted with snow tires or tire chains. Always drive at an appropriate and cautious pace.

VEHICLE STABILITY CONTROL SYSTEM

The vehicle stability control system helps provide integrated control of the systems such as an anti-lock brake system, traction control, engine control, etc. This system automatically controls the output of the brakes or engine to help prevent the vehicle from skidding when cornering on a slippery road surface or abrupt steering wheel operation occurs.



► Slip indicator light

If the vehicle is going to skid during driving, the slip indicator light flashes and an alarm sounds intermittently.

The vehicle stability control activates when the vehicle speed is about more than 15 km/h (9 mph).

You may hear a sound in the engine compartment for a few seconds when the engine is started or just after the vehicle begins to move. This means that the vehicle stability control is in the self-check mode and does not indicate a malfunction.



You can turn off the vehicle stability control system by pushing the "VSC OFF" switch. The "VSC OFF" indicator comes on. At this time, the traction control system also turns off. You cannot turn off either one of them. Pushing the "VSC OFF" switch a second time turns the system back on and extinguishes the "VSC OFF" indicator light.

When you turn the ignition switch on, this system always turns on.

Vehicle stability control system failure warning



These lights warn when there is a problem somewhere in the vehicle stability control system or traction control system.

If the "VSC" warning light and "VSC OFF" indicator light come on, have your vehicle checked by Lexus dealer as soon as possible.

The lights will come on when the ignition key is turned to "ON", and will go off after about a few seconds.

The lights may stay on for 60 seconds after the ignition key is turned to the "ON" position. It is normal if they go out after a while.

Depressing the brake pedal repeatedly may turn on the lights. It is normal if they go out after a few seconds.

If the "VSC" warning light and "VSC OFF" indicator light come on, the vehicle stability control system does not activate, however, it is no problem to continue your driving.

STARTING AND DRIVING

CAUTION

- Do not rely excessively on the vehicle stability control system. Even if the vehicle stability control system is operating, you must always drive carefully and attentively to avoid serious injury. Reckless driving will result in an unexpected accident. If the slip indicator light flashes, sounding an alarm, special care should be taken while driving.
- Only use tires of specified size. The size, manufacturer, brand and tread pattern for all 4 tires should be the same. If you use the tires other than specified, or different type or size, the vehicle stability control system may not function correctly. When replacing the tires or wheels, contact your Lexus dealer.

BRAKE SYSTEM

This brake system has 2 independent hydraulic circuits. If either circuit should fail, the other will still work. However, the pedal will be harder to press, and your stopping distance will increase. Also, the brake system warning light may come on.

CAUTION

Do not drive your vehicle with only a single brake system. Have your brakes fixed immediately.

Brake booster

The brake booster uses brake fluid pressurized by the pump to power-assist the brakes. If the brake booster fails during driving, the brake system warning light comes on and buzzer sounds continuously. In this case, the brakes may not work properly. If they do not work well, depress the brake pedal firmly. If the brake system warning light comes on, immediately stop your vehicle and contact your Lexus dealer.

The brake system warning light may stay on for about 60 seconds after the ignition key is turned to the "ON" position. It is normal if the light turns off after a while.

Depressing the brake pedal repeatedly may turn on the brake system warning light and buzzer. It is normal if the light goes out and the buzzer stops sounding after a few seconds.

You may hear a small sound in the engine compartment after the engine is started or the brake pedal is depressed repeatedly. This is a pump pulsating sound of the brake system, and it is not a malfunction.

CAUTION

- **Do not pump the brake pedal if the engine stalls. Each push on the pedal uses up your brake fluid pressure reserve.**
- **Even if the power assist is completely lost, the brakes will still work. But you will have to push the pedal hard, much harder than normal. And your braking distance will increase.**

Anti-lock brake system

The anti-lock brake system is designed to automatically help prevent lock-up of the wheels during a sudden braking or braking on slippery road surfaces. This assists in providing directional stability and steering performance of the vehicle under these circumstances.

Effective way to press the ABS brake pedal: When the anti-lock brake system function is in action, you may feel the brake pedal pulsating and hear a noise. In this situation, to let the anti-lock brake system work for you, just hold the brake pedal down more firmly. Do not pump the brake in a panic stop. This will result in reduced braking performance.

The anti-lock brake system becomes operative after the vehicle has accelerated to a speed in excess of approximately 10 km/h (6 mph). It stops operating when the vehicle decelerates to a speed below approximately 5 km/h (3 mph).

Depressing the brake pedal on slippery road surfaces such as on a manhole cover, a steel plate at a construction site, joints in a bridge, etc. on a rainy day tends to activate the anti-lock brake system.

You may hear a click or motor sound in the engine compartment for a few seconds when the engine is started or just after the vehicle begins to move. This means that the anti-lock brake system is in the self-check mode, and does not indicate a malfunction.

When the anti-lock brake system is activated, the following conditions may occur. They do not indicate a malfunction of the system:

- You may hear the anti-lock brake system operating and feel the brake pedal pulsating and the vibrations of the vehicle body and steering wheel. You may also hear the motor sound in the engine compartment even after the vehicle is stopped.
- At the end of the anti-lock brake system activation, the brake pedal may move a little forward.

STARTING AND DRIVING



CAUTION

Do not overestimate the anti-lock brake system: Although the anti-lock brake system assists in providing vehicle control, it is still important to drive with all due care and maintain a moderate speed and safe distance from the vehicle in front of you, because there are limits to the vehicle stability and effectiveness of steering wheel operation even with the anti-lock brake system on.

If tire grip performance exceeds its capability, or if hydroplaning occurs during high speed driving in the rain, the anti-lock brake system does not provide vehicle control.

Anti-lock brake system is not designed to shorten the stopping distance: Always drive at a moderate speed and maintain a safe distance from the vehicle in front of you. Compared with vehicles without an anti-lock brake system, your vehicle may require a longer stopping distance in the following cases:

- Driving on rough, gravel or snow-covered roads.
- Driving with tire chains installed.

- Driving over the steps such as the joints on the road.
- Driving on roads where the road surface is pitted or has other differences in surface height.

Install all 4 tires of specified size at appropriate pressure: The anti-lock brake system detects vehicle speeds using the speed sensors for respective wheels' turning speeds. The use of tires other than specified may fail to detect the accurate turning speed resulting in a longer stopping distance.

"ABS" warning light

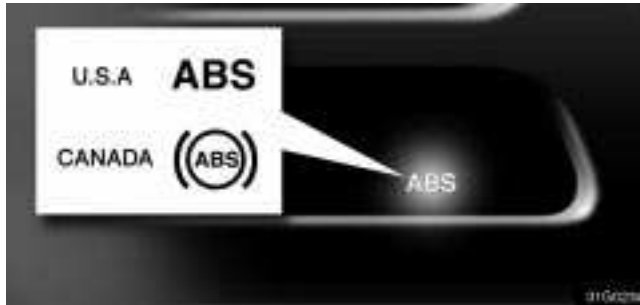

The light comes on when the ignition key is turned to the "ON" position. If the anti-lock brake system and the brake assist system work properly, the light turns off after a few seconds. Thereafter, if either of the systems malfunctions, the light comes on again.

When the "ABS" warning light is on (and the brake system warning light is off), the anti-lock brake system, the brake assist system, the traction control system and/or the vehicle stability control system do/does not operate, but the brake system still operates conventionally.

When the "ABS" warning light is on (and the brake system warning light is off), the anti-lock brake system does not operate so that the wheels could lock up during a sudden braking or braking on slippery road surfaces.

If either of the following conditions occur, this indicates a malfunction somewhere in the components monitored by the warning light system. Contact your Lexus dealer as soon as possible to service the vehicle.

- The light does not come on when the ignition key is turned to the "ON" position, or remains on.
- The light comes on while you are driving.

A warning light turning on briefly during operation does not indicate a problem.



CAUTION

If the "ABS" warning light remains on together with the brake system warning light, immediately stop your vehicle at a safe place and contact your Lexus dealer.

In this case, not only the anti-lock brake system will fail but also the vehicle will become extremely unstable during braking.

Either of the following conditions may occur, but do not indicate a malfunction:

- The light may stay on for about 60 seconds after the ignition key is turned to the "ON" position. It is normal if it turns off after a while.
- Depressing the brake pedal repeatedly may turn on the light. It is normal if it turns off after a few seconds.

STARTING AND DRIVING

Drum-in-disc type parking brake system

Your vehicle has a drum-in-disc type parking brake system. This type of brake system needs bedding-down of the brake shoes periodically or whenever the parking brake shoes and/or drums are replaced.

Have your Lexus dealer perform the bedding-down.

Brake assist system

When you slam the brakes on, the brake assist system judges as an emergency stop and provides more powerful braking for a driver who cannot hold down the brake pedal firmly.

When you slam the brakes on, more powerful braking will be applied. At this time, you may hear a sound in the engine compartment and feel the vibrations of the brake pedal. This does not indicate a malfunction.

The brake assist system becomes operative after the vehicle has accelerated to a speed in excess of approximately 10 km/h (6 mph). It stops operating when the vehicle decelerates to a speed below approximately 5 km/h (3 mph).

The brake assist system may not work for about 60 seconds after the engine is started.

For an explanation of this system's warning light, see "ABS" warning light on page 47 or 199.

BRAKE PAD WEAR LIMIT INDICATORS



The brake pad wear limit indicators on your disc brakes give a warning noise when the brake pads are worn to the extent that replacement is required.

If you hear a squealing or scraping noise while driving, have the brake pads checked and replaced by your Lexus dealer as soon as possible. Expensive rotor damage can result if the pads are not replaced when needed.

TYPES OF TIRES

Determine what kind of tires your vehicle is originally equipped with.

1. Summer tires

Summer tires are high-speed capability tires best suited to highway driving under dry conditions.

Since summer tires do not have the same traction performance as snow tires, summer tires are inadequate for driving on snow-covered or icy roads. For driving on snow-covered or icy roads, we recommend using snow tires. If installing snow tires, be sure to replace all four tires.

2. All season tires

All season tires are designed to provide better traction in snow and to be adequate for driving in most winter conditions, as well as for use all year round.

All season tires, however, do not have adequate traction performance compared with snow tires in heavy or loose snow. Also, all season tires fall short in acceleration and handling performance compared with summer tires in highway driving.



CAUTION

- Do not mix summer and all season tires on your vehicle as this can cause dangerous handling characteristics, resulting in loss of control.
- Do not use tires other than the manufacturer's designated tires, and never mix tires or wheels of the sizes different from the originals.

SECTION 3-2

STARTING AND DRIVING

Driving tips

Break-in period	204
Operation in foreign countries	204
Tips for driving in various conditions	204
Winter driving tips	206
Dinghy towing	207
Trailer towing	207
How to save fuel and make your vehicle last longer	208

DRIVING TIPS

BREAK-IN PERIOD

Drive gently and avoid high speeds.

You need not follow a break-in schedule with your new Lexus. But following a few simple tips for the first 1600 km (1000 miles) can add to the future economy and long life of your vehicle:

- Avoid full throttle acceleration when starting and driving.
- Avoid racing the engine.
- Try to avoid hard stops during the first 300 km (200 miles).
- Do not drive for a long time at any single speed, either fast or slow.

OPERATION IN FOREIGN COUNTRIES

If you plan to drive your Lexus in another country ...

First, comply with the vehicle registration laws.

Second, confirm the availability of the correct fuel (unleaded and minimum octane rating).

TIPS FOR DRIVING IN VARIOUS CONDITIONS

- Always slow down in gusty crosswinds. This will allow you much better control.
- Drive slowly onto curbs and, if possible, at a right angle. Avoid driving onto high, sharp-edged objects and other road hazards. Failure to do so can lead to severe tire damage such as a tire burst. Drive slowly when passing over bumps or travelling on a bumpy road. Otherwise, the impact could cause severe damage to the tires and/or wheels.
- When parking on a hill, turn the front wheels until they touch the curb so that the vehicle will not roll. Apply the parking brake, and place the transmission in "P". If necessary, block the wheels.
- Washing your vehicle or driving through deep water may get the brakes wet. To see whether they are wet, check that there is no traffic near you and then press the pedal lightly. If you do not feel a normal braking force, the brakes are probably wet. To dry them, drive the vehicle cautiously while lightly pressing the brake pedal with the parking brake applied. If they still do not work safely, pull to the side of the road and call a Lexus dealer for assistance.

 CAUTION

- Before driving off, make sure the parking brake is fully released and that the parking brake reminder light is off.
- Do not leave your vehicle unattended while the engine is running.
- Do not rest your foot on the brake pedal while driving. It can cause dangerous overheating, needless wear, and poor fuel economy.
- To drive down a long or steep hill, reduce your speed and downshift. Remember, if you ride the brakes excessively, they may overheat and not work properly. See page 186.
- Be careful when accelerating, upshifting, downshifting or braking on a slippery surface. The abrupt change in engine speed, such as sudden acceleration or engine braking, could cause the vehicle to spin or skid.
- Even if the legal speed limit permits it, do not drive over 140 km/h (85 mph) unless your vehicle has high-speed capability tires. Driving over 140 km/h (85 mph) may result in tire failure, loss of control and possible injury. Be sure to consult a tire dealer to determine whether the tires on your vehicle are high-speed capability tires or not before driving at such speeds.

- Do not continue normal driving when the brakes are wet. If they are wet, your vehicle will require a longer stopping distance, and it may pull to one side when the brakes are applied. Also, the parking brake will not hold the vehicle securely.

DRIVING TIPS

WINTER DRIVING TIPS

Make sure your coolant is properly protected against freezing.

Your coolant must contain ethylene–glycol type coolant for a proper corrosion protection of aluminum components. Use "Toyota Genuine Long Life Coolant" or equivalent. See "Checking the engine coolant level" on page 264 for instructions.

NOTICE

Do not use alcohol type antifreeze or plain water alone.

When it is extremely cold, we recommend to use 60% solution for your Lexus, to provide protection down to about -50°C (-58°F). Do not use more than 70% solution for better coolant performance.

Check the condition of the battery and cables.

Cold temperatures reduce the capacity of any battery, so it must be in top shape to provide enough power for winter starting. Page 296 tells you how to visually inspect the battery. Your Lexus dealer and most service stations will be pleased to check the battery charge level.

Make sure the engine oil viscosity is suitable for the cold weather.

See page 263 for recommended viscosity. Leaving a heavy summer oil in your vehicle during winter months may cause harder starting. If you are not sure about which oil to use, call your Lexus dealer – they will be pleased to help.

Check the electronic ignition system for loose connections or obvious damage.

Keep the door locks from freezing.

Squirt lock de–icer or glycerine into the locks to keep them from freezing.

Use a washer fluid containing an antifreeze solution.

This product is available at your Lexus dealer and most auto parts stores. Follow the manufacturer's directions for how much to mix with water.

NOTICE

Do not use engine antifreeze or any other substitute because it may damage your vehicle's paint.

Do not use your parking brake when there is a possibility it could freeze.

When parking, put the transmission into "P" and block the front wheels. Do not use the parking brake, or snow or water accumulated in and around the parking brake mechanism may freeze the parking brake, making it hard to release.

Keep ice and snow from accumulating under the fenders.

Ice and snow built up under your fenders can make steering difficult. During bad winter driving, stop and check under the fenders occasionally.

Depending on where you are driving, we recommend you carry some emergency equipment.

Some of the things you might put in the vehicle are tire chains, window scraper, bag of sand or salt, flares, small shovel, jumper cables, etc.

DINGHY TOWING

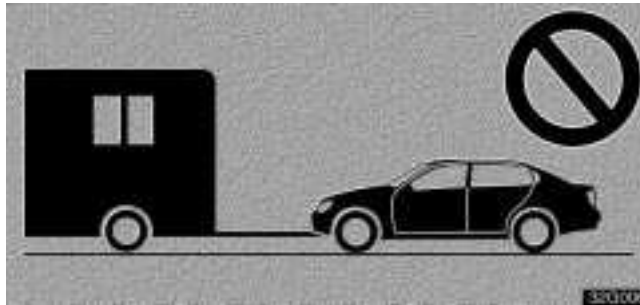

Your vehicle is not designed to be dinged towed (with four wheels on the ground) behind a motorhome.

NOTICE

Do not tow your vehicle with four wheels on the ground. This may cause serious damage to your vehicle.

TRAILER TOWING

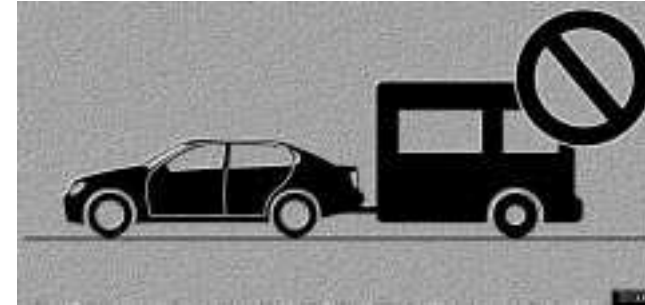

Lexus does not recommend towing a trailer with your vehicle. It is not designed for trailer towing.

DRIVING TIPS

HOW TO SAVE FUEL AND MAKE YOUR VEHICLE LAST LONGER

Improving fuel economy is easy – just take it easy. It will help make your vehicle last longer, too. Here are some specific tips on how to save money on both fuel and repairs:

- **Keep your tires inflated at the correct pressure.** Check the pressure every two weeks, or at least once a month. Underinflation causes tire wear and wastes fuel.
- **Do not carry unneeded weight in your vehicle.** Excess weight puts a heavier load on the engine, causing greater fuel consumption.
- **Avoid lengthy warm-up idling.** Once the engine is running smoothly, begin driving – but gently. Remember, however, that on cold winter days this may take a little longer.
- **Accelerate slowly and smoothly.** Avoid jackrabbit starts.
- **Avoid long engine idling.** If you have a long wait and you are not in traffic, it is better to turn off the engine and start again later.
- **Avoid engine over-revving.** Use a gear position suitable for the road on which you are traveling.
- **Avoid continuous speeding up and slowing down.** Stop-and-go driving wastes fuel.
- **Avoid unnecessary stopping and braking.** Maintain a steady pace. Try to time the traffic signals so you only need to stop as little as possible or take advantage of through streets to avoid traffic lights. Keep a proper distance from other vehicles to avoid sudden braking. This will also reduce wear on your brakes.
- **Avoid heavy traffic or traffic jams whenever possible.**
- **Do not rest your foot on the brake pedal.** This causes premature wear, overheating and poor fuel economy.
- **Maintain a moderate speed on highways.** The faster you drive, the greater the fuel consumption. By reducing your speed, you will cut down on fuel consumption.
- **Keep the front wheels in proper alignment.** Avoid hitting the curb and slow down on rough roads. Improper alignment not only causes faster tire wear but also puts an extra load on the engine, which, in turn, wastes fuel.
- **Keep the bottom of your vehicle free from mud, etc.** This not only lessens weight but also helps prevent corrosion.
- **Keep your vehicle tuned-up and in top shape.** A dirty air cleaner, improper valve clearance, dirty plugs, dirty oil and grease, brakes not adjusted, etc. all lower engine performance and contribute to poor fuel economy. For longer life of all parts and lower operating costs, keep all maintenance work on schedule, and if you often drive under severe conditions, see that your vehicle receives more frequent maintenance (For scheduled maintenance information, please refer to the “Owner’s Manual Supplement / Scheduled Maintenance”).

 **CAUTION**

Never turn off the engine to coast down hills. Your power steering and brake booster will not function without the engine running. Also, the emission control system operates properly only when the engine is running.

SECTION 4

IN CASE OF AN EMERGENCY

In case of an emergency

If your engine stalls while driving	212
If your vehicle will not start	212
If you cannot increase the engine speed	217
If your vehicle overheats	217
If you have a flat tire	218
If your vehicle becomes stuck	225
If your vehicle needs to be towed	226
If you cannot shift automatic transmission selector lever	230
If you lose your keys or lock yourself out	231

IN CASE OF AN EMERGENCY

IF YOUR ENGINE STALLS WHILE DRIVING

If your engine stalls while driving

1. Reduce your speed gradually, keeping a straight line. Move cautiously off the road to a safe place.
2. Turn on your emergency flashers.
3. Try starting the engine again.

If the engine will not start, see "If your vehicle will not start".



CAUTION

If the engine is not running, the power assist for the brakes and steering will not work, so steering and braking will be much harder than usual.

IF YOUR VEHICLE WILL NOT START

(a) Simple checks

Before making these checks, make sure you have followed the correct starting procedure instructions in "How to start the engine" on page 180 and that you have sufficient fuel. Since your vehicle is equipped with the engine immobiliser system, also check whether the other keys will start the engine. If they work, your key may be broken. Have the key checked at your Lexus dealer. If none of your keys work, there may be a malfunction in the immobiliser system. Call your Lexus dealer. See "Keys" on page 8.

If the engine is not turning over or is turning over too slowly –

1. Check that the battery terminals are tight and clean.
2. If the battery terminals are O.K., switch on the interior light.
3. If the light is out, dim or goes out when the starter is cranked, the battery is discharged. You may try jump starting. See "(c) Jump starting" for further instruction.

If the light is O.K., but the engine still will not start, it needs adjustment or repair. Call a Lexus dealer, Roadside Assistance or Customer Service Assistance. (See "Foreword".)

NOTICE

Do not pull- or push-start the vehicle. It may damage the vehicle or cause a collision when the engine starts. Also the three-way catalytic converter may overheat and become a fire hazard.

If the engine turns over at its normal speed but will not start –

1. The engine may be flooded because of repeated cranking. See "(b) Starting a flooded engine" for further instructions.
2. If the engine still will not start, it needs adjustment or repair. Call a Lexus dealer, Roadside Assistance or Customer Service Assistance. (See "Foreword".)

(b) Starting a flooded engine

If the engine will not start, your engine may be flooded because of repeated cranking.

If this happens, turn the key to "START" with the accelerator pedal fully depressed. Continue this operation for 30 seconds and then stop cranking. Then try starting the engine with your foot off the accelerator pedal.

If the engine does not start after 30 seconds of cranking, release the key, wait a few minutes and try again.

If the engine still will not start, it needs adjustment or repair. Call a Lexus dealer, Roadside Assistance or Customer Service Assistance. (See "Foreword".)

NOTICE

Do not crank for more than 30 seconds at a time. This may overheat the starter and wiring systems.

IN CASE OF AN EMERGENCY

(c) Jump starting

To avoid serious personal injury and damage to your vehicle which might result from battery explosion, acid burns, electrical burns, or damaged electronic components, these instructions must be followed precisely.

If you are unsure about how to follow this procedure, we strongly recommend that you seek help from your Lexus dealer, Roadside Assistance or Customer Service Assistance. (See "Foreword").



CAUTION

- Batteries contain sulfuric acid which is poisonous and corrosive. Wear protective safety glasses when jump starting, and avoid spilling acid on your skin, clothing, or vehicle.
- If you should accidentally get acid on yourself or in your eyes, remove any contaminated clothing and flush the affected area with water immediately. Then get immediate medical attention. If possible, continue to apply water with a sponge or cloth while en route to the medical office.
- The gas normally produced by a battery will explode if a flame or spark is brought near. Use only standardized jumper cables and do not smoke or light a match while jump starting.

- **Warning:** Battery posts, terminals and related accessories contain lead and lead compounds, chemicals known to the State of California to cause cancer and reproductive harm. Wash hands after handling.

NOTICE

The battery used for boosting must be 12 V. Do not jump start unless you are sure that the booster battery is correct.

IN CASE OF AN EMERGENCY

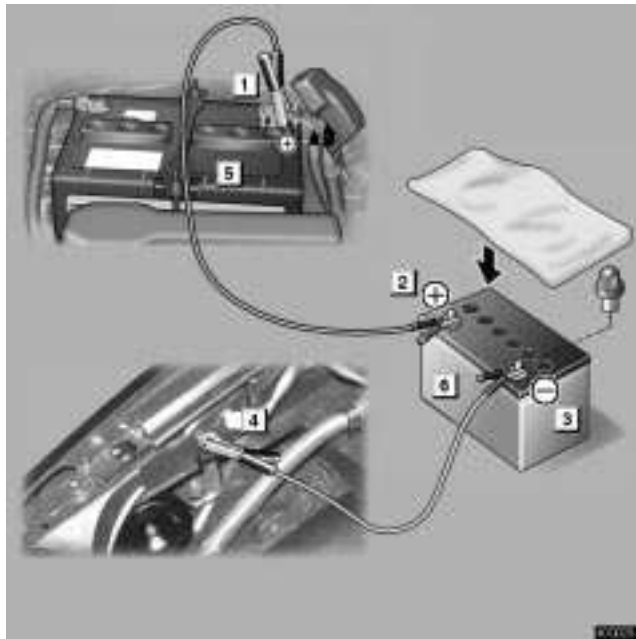

► **GS430** 5 Discharged battery 6 Booster battery

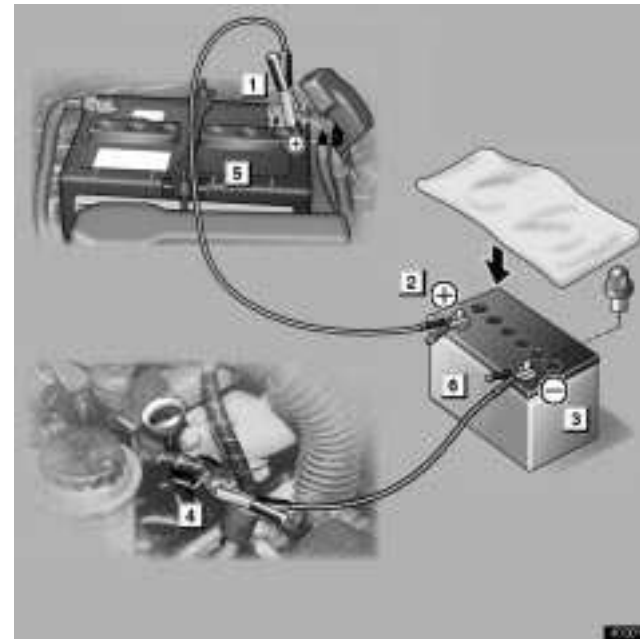

► **GS300** 5 Discharged battery 6 Booster battery

JUMP STARTING PROCEDURE

1. If the booster battery is installed in another vehicle, make sure the vehicles are not touching. Turn off all unnecessary lights and accessories.

IN CASE OF AN EMERGENCY

2. If required, remove all the vent plugs from the booster battery. Lay a cloth over the open vents on the booster battery. (This helps reduce the explosion hazard, personal injuries and burns.)

If the booster battery is an extended maintenance interval battery, it is not necessary to remove the vent plugs.

3. If the engine in the vehicle with the booster battery is not running, start it and let it run for about 5 minutes. During jump starting, run the engine at about 2000 rpm with the accelerator pedal lightly depressed.

4. Locate positive (+) and negative (-) terminals of each battery. Connect the jumper cables in the exact order (**1** **2** **3** **4**) shown in the illustration.

- 1** Connect a positive (red) jumper cable clamp to the positive (+) terminal of the discharged battery.
- 2** Connect the clamp at the other end of the positive (red) cable to the positive (+) terminal of the booster battery.
- 3** Connect a negative (black) cable clamp to the negative (-) terminal of the booster battery.
- 4** Connect the clamp at the other end of the negative (black) cable to a solid, stationary, unpainted metallic point (such as shown in the illustration) away from the battery. Do not connect it to or near any part that moves when the engine is cranked.

CAUTION

When making the connections, to avoid serious injury, do not lean over the battery or accidentally let the jumper cables or clamps touch anything except the correct battery terminals or the ground.

5. Start your engine in the normal way. After starting, run it at about 2000 rpm for several minutes with the accelerator pedal lightly depressed.

6. Carefully disconnect the cables in the exact reverse order: the negative cable and then the positive cable.

7. Carefully dispose of the battery cover cloths which may now contain sulfuric acid.

8. If removed, replace all the battery vent plugs.

If the cause of your battery discharging is not apparent (for example, lights left on), you should have it checked at your Lexus dealer.

IF YOU CANNOT INCREASE THE ENGINE SPEED

If the engine speed does not increase when the accelerator pedal is depressed, the electronic throttle control system may be faulty. Move the vehicle to a safe place by means of creeping and call a Lexus dealer for assistance:

1. Depress the brake pedal and shift to the "D" position.
2. Gradually release the brake pedal, and the vehicle starts to move by creeping. After arriving at a safe place, stop the vehicle and call a Lexus dealer for assistance.

CAUTION

- The above method of moving the vehicle is for emergency. Use it only for moving minimum distances to a safe place.
- Be especially careful to prevent erroneous pedal operation.

IF YOUR VEHICLE OVERHEATS

If your engine coolant temperature gauge indicates overheating, if you experience a loss of power, or if you hear a loud knocking or pinging noise, the engine has probably overheated.

When the engine overheats

Pull safely off the road, stop the vehicle and turn on your emergency flashers. Put the transmission in "P" and apply the parking brake.

A: If steam is coming from your engine:

Turn off the engine. Leave the hood closed until there is no sign of steam or coolant. Your engine could have been seriously damaged already. Call your Lexus dealer for assistance.

CAUTION

To help avoid personal injury, keep the hood closed until there is no steam. Escaping steam or coolant is sign of very high pressure.

IN CASE OF AN EMERGENCY

B: If no steam is coming from your engine:

Leave the engine running and turn off the air conditioning. Check the following.

- Is the cooling fan operating?
- Is the coolant in the acceptable range?
- Is the engine drive belt O.K.?

 CAUTION
<ul style="list-style-type: none">• When the engine is running, keep hands and clothing away from the moving fan and engine drive belt.• Do not attempt to remove the radiator cap when the engine and radiator are hot. Serious injury could result from scalding hot fluid and steam blown out under pressure.

If the cooling fan is not operating or the coolant is not in the acceptable range, turn off the engine and call your Lexus dealer.

If both conditions are O.K., after the engine coolant temperature has cooled to normal, continue driving your vehicle.

If the engine coolant temperature does not cool down, or your vehicle overheats again, have it checked as soon as possible by your Lexus dealer.

IF YOU HAVE A FLAT TIRE

1. Reduce your speed gradually, keeping a straight line. Move cautiously off the road to a safe place – well away from the traffic. Avoid stopping on the center divider of a highway. Park on a level spot with firm ground.
2. Stop the engine and turn on your emergency flashers.
3. Firmly set the parking brake and put the transmission in "P".
4. Have everyone get out of the vehicle on the side away from traffic.
5. Read the following instructions thoroughly.

 CAUTION
<p>When jacking, be sure to observe the following to reduce the possibility of personal injury:</p> <ul style="list-style-type: none">• Follow jacking instructions.• Do not put any part of your body under the vehicle supported by a jack. Otherwise, personal injury may occur.• Do not start or run the engine while your vehicle is supported by the jack.

IN CASE OF AN EMERGENCY

- Stop the vehicle on a level firm ground, firmly set the parking brake and put the transmission in "P". Block the wheel diagonally opposite to the one being changed if necessary.
- Make sure to set the jack properly in the jack point. Raising the vehicle with jack improperly positioned will damage the vehicle or may allow the vehicle to fall off the jack and cause personal injury.
- Never get under the vehicle when the vehicle is supported by the jack alone.
- Use the jack only for lifting your vehicle during wheel changing.
- Do not raise the vehicle with someone in the vehicle.
- When raising the vehicle, do not put an object on or under the jack.
- Raise the vehicle only high enough to remove and change the tire.

NOTICE

Do not continue driving with a deflated tire. Driving even a short distance can damage a tire and wheel beyond repair.



- **1** Tool bag **2** Jack **3** Wrench **4** Jack handle
5 Spare tire

1. Get the jack, wrench and spare tire.

To prepare yourself for an emergency, you should familiarize yourself with the use of the jack and each tool, and their storage locations.

IN CASE OF AN EMERGENCY

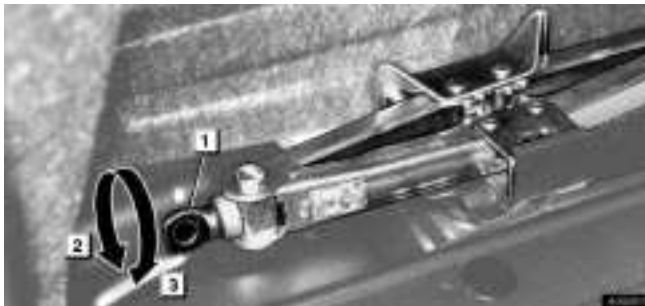

- **1 Joint**
- 2** When removing the jack, turn the joint by hand in the "contract" direction until the jack is free.
 - 3** When storing, turn the joint by hand in the "expand" direction until the jack is firmly secured to prevent it from flying forward during a collision or sudden braking.



To remove the spare tire:

- 1** Remove the luggage tray.
- 2** Loosen the bolt and remove it.

When storing the spare tire, place it with the inner side of the wheel facing up. Then bolt the tire in place and install the luggage tool box to prevent the tire from flying forward during a collision or sudden braking.

IN CASE OF AN EMERGENCY



2. Block the wheel diagonally opposite the flat tire to keep the vehicle from rolling when it is jacked up.

When blocking the wheel, place a wheel block in front of one of the front wheels or behind one of the rear wheels.



3. Loosen all the wheel nuts.

Always loosen the wheel nuts before raising the vehicle.

Turn the wheel nuts counterclockwise to loosen them. To get maximum leverage, fit the wrench to the nut so that the handle is on the right side, as shown above. Grab the wrench near the end of the handle and pull up on the handle. Be careful that the wrench does not slip off the nut.

Do not remove the nuts yet – just unscrew them about one-half turn.



CAUTION

Never use oil or grease on the bolts or nuts. The nuts may loosen and the wheels may fall off, which could cause a serious accident.

IN CASE OF AN EMERGENCY

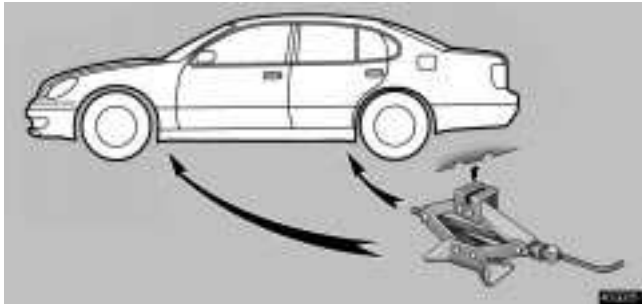

4. Position the jack at the jack points as shown.

Make sure the jack is positioned on a level and solid surface.



5. After making sure no one is in the vehicle, raise it high enough so that the spare tire can be installed.

Allow for the fact that you need more ground clearance when putting on the spare tire than when removing the flat tire.

To raise the vehicle, insert the jack handle into the jack (it is a loose fit) and turn it clockwise. As the jack touches the vehicle and begins to lift, double-check that it is properly positioned.

 **CAUTION**

Never get under the vehicle when the vehicle is supported by the jack alone.

IN CASE OF AN EMERGENCY



6. Remove the wheel nuts and remove the flat tire.

Lift the flat tire straight off and put it aside.



Before putting on the wheel, remove any corrosion on the mounting surfaces with a wire brush or such. Installation of wheels without good metal-to-metal contact at the mounting surface can cause wheel nuts to loosen and eventually cause a wheel to come off while driving.



7. Reinstall all the wheel nuts finger tight.

Align the holes in the wheel with the bolts. Then lift up the wheel and get at least the top bolt started through its hole. Wiggle the tire and press it back over the other bolts.

Reinstall the wheel nuts and tighten them as much as you can by hand. Press the tire back and see if you can tighten them more.



CAUTION

Never use oil or grease on the bolts or nuts. Doing so may lead to overtightening the nuts and damaging the bolts. The nuts may loosen and the wheels may fall off, which could cause a serious accident. If there is oil or grease on any bolt or nut, clean it.

IN CASE OF AN EMERGENCY



8. Lower the vehicle completely and tighten the wheel nuts.

Turn the jack handle counterclockwise to lower the vehicle.

Use only the wheel nut wrench to tighten the nuts. Do not use other tools or any additional leverage other than your hands, such as a hammer, pipe or your foot. Make sure the wrench is securely engaged over the nut.

Tighten each nut a little at a time in the order shown. Repeat the process until all the nuts are tight.

CAUTION

- When lowering the vehicle, make sure all portions of your body and all other persons around will not be injured as the vehicle is lowered to the ground.

- Have the wheel nuts tightened with torque wrench to 103 N·m (10.5 kgf·m, 76 ft·lbf.), as soon as possible after changing wheels. Otherwise, the nuts may loosen and the wheels may fall off, which could cause a serious accident.

9. After changing the wheel, check the air pressure of the replaced tire. Stow all the tools, jack and flat tire securely.

If the pressure of the replaced tire is low, drive slowly to the nearest service station and fill to the correct pressure.

Do not forget to reinstall the tire valve cap as dirt and moisture could get into the valve core and possibly cause air leakage. If the cap is missing, put a new one on as soon as possible.

This is the same procedure for changing or rotating your tires.

CAUTION

- When reinstalling a standard tire, take due care in handling the ornament to avoid unexpected personal injury.
- Before driving, make sure all the tools, jack and flat tire are securely in place in their storage location to reduce the possibility of personal injury during a collision or sudden braking.

IF YOUR VEHICLE BECOMES STUCK

If your vehicle becomes stuck in snow, mud, sand, etc. then you may attempt to rock the vehicle free by moving it forward and backward.

Turn off the traction control system to become unstuck to allow the tires to spin enough to remove the vehicle from the obstruction. (For details, see "Vehicle stability control system" on page 194.)

CAUTION

Do not attempt to rock the vehicle free by moving it forward and backward if people or objects are anywhere near the vehicle. During the rocking operation the vehicle may suddenly move forward or backward as it becomes unstuck, causing injury or damage to nearby people or objects.

NOTICE

If you rock your vehicle, observe the following precautions to prevent damage to the transmission and other parts.

- *Do not depress the accelerator pedal while shifting the selector lever or before the transmission is completely shifted to forward or reverse gear.*
- *Do not race the engine and avoid spinning the wheels.*
- *If your vehicle remains stuck after rocking the vehicle several times, consider other ways such as towing.*

IN CASE OF AN EMERGENCY

IF YOUR VEHICLE NEEDS TO BE TOWED

If towing is necessary, we recommend you to have it done by your Lexus dealer or a commercial tow truck service. In consultation with them, have your vehicle towed using either (a) or (b).

- (a) Towing with a wheel lift type truck
- (b) Using a flat bed truck
- (c) Never tow with a sling type truck

Only when you cannot receive a towing service from a Lexus dealer or commercial tow truck service, tow your vehicle carefully in accordance with the instructions given in "(d) Emergency towing" on page 229.

Proper equipment will help ensure that your vehicle is not damaged while being towed. Commercial operators are generally aware of the state/provincial and local laws pertaining to towing.

Your vehicle can be damaged if it is towed incorrectly. Although most operators know the correct procedure, it is possible to make a mistake. To avoid damage to your vehicle, make sure the following precautions are observed. If necessary, show this page to the tow truck driver.

TOWING PRECAUTIONS:

Use a safety chain system for all towing, and abide by the state/provincial and local laws. The wheels and axle on the ground must be in good condition. If they are damaged, use a towing dolly.

(a) Towing with a wheel lift type truck

- From front

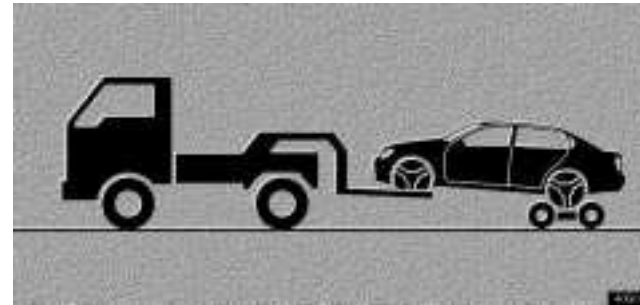

Use a towing dolly under the rear wheels.

NOTICE

Never tow a vehicle with an automatic transmission from the front with rear wheels on the ground, as this may cause serious damage to the transmission.

- From rear

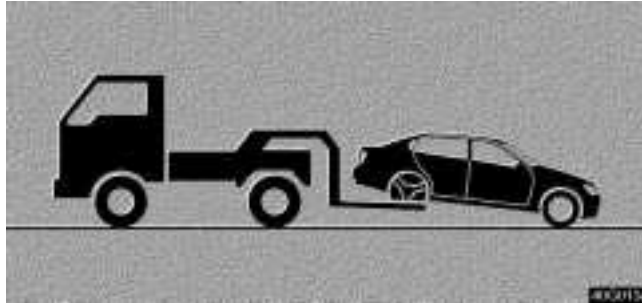

Place the ignition key in the "ACC" position.

NOTICE

- *Do not tow with the key removed or in the "LOCK" position, as the steering lock mechanism is not strong enough to hold the front wheels straight.*
- *When lifting wheels, take care to ensure adequate ground clearance for towing at the opposite end of the raised vehicle. Otherwise, the bumper and/or underbody of the towed vehicle will be damaged during towing.*

- (b) Using a flat bed truck

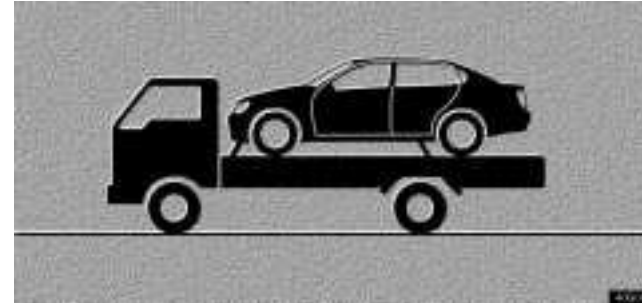

- Tie down points

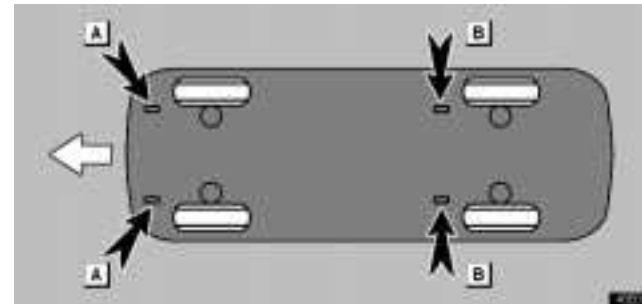

IN CASE OF AN EMERGENCY

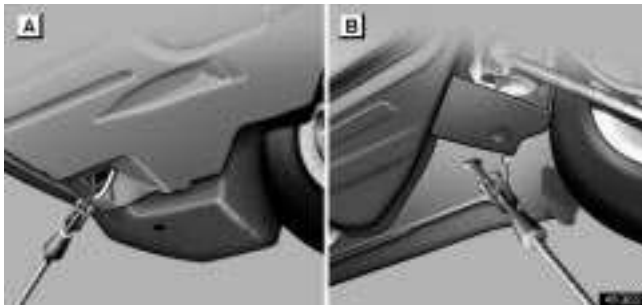

If your Lexus is transported by a flat bed, it should be tied down at locations A and B as shown above.



► **Rear emergency towing eyelets**

NOTICE

Do not use the rear emergency towing eyelets.

- **Tie down angle**

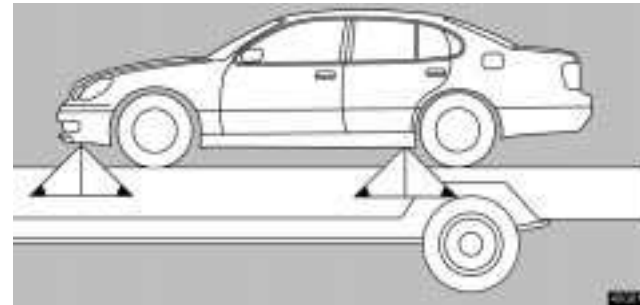

If you use chains or wires to tie down your vehicle, the angles shaded black must be at 45°.

(c) Towing with a sling type truck

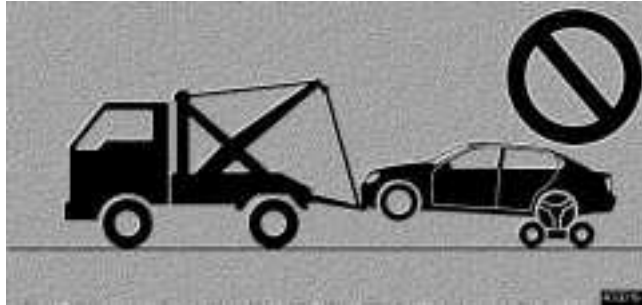

NOTICE

Do not tow with a sling type truck, either from the front or rear. This may cause body damage.

(d) Emergency towing



If towing is necessary, we recommend you to have it done by your Lexus dealer or a commercial tow truck service.

If towing service is not available in an emergency, your vehicle may be temporarily towed by a cable or chain secured to the emergency towing eyelet. Use extreme caution when towing the vehicle.

A driver must be in the vehicle to steer it and operate the brakes.

Towing in this manner may be done only on hard-surfaced roads for a short distance and at low speeds. Also, the wheels, axles, drive train, steering and brakes must all be in good condition.

IN CASE OF AN EMERGENCY

CAUTION

Use extreme caution when towing the vehicle. Avoid sudden starts or erratic driving maneuvers which would place excessive stress on the emergency towing eyelet and towing cable or chain. The eyelet and towing cable or chain may break and cause serious injury or damage.

NOTICE

Use only a cable or chain specifically intended for use in towing vehicles. Securely fasten the cable or chain to the towing eyelet provided.

Before towing, release the parking brake and put the transmission in "N". The ignition key must be in "ACC" (engine off) or "ON" (engine running).

CAUTION

If the engine is not running, the power assist for the brakes and steering will not work so steering and braking will be much harder than usual.

IF YOU CANNOT SHIFT AUTOMATIC TRANSMISSION SELECTOR LEVER



If you cannot shift the selector lever, use the shift lock override button as follows:

- 1 Turn the ignition key to "LOCK" or "ACC". Make sure the parking brake is applied. Pry up the cover with a flat-bladed screwdriver or equivalent.



- 2 Insert your finger, the screwdriver or equivalent into the hole to push down the shift lock override button. You can shift the selector lever while pushing the button.

For your safety, keep the brake pedal depressed.

Be sure to have the system checked by your Lexus dealer as soon as possible.

IF YOU LOSE YOUR KEYS OR LOCK YOURSELF OUT

You can purchase a new key at your Lexus dealer if you can give them the key number and master key.

Even if you lose only one key, contact your Lexus dealer to make a new key. If you lose all your master keys, you cannot make new keys; the whole engine immobiliser system must be replaced.

See the suggestion given in "Keys" on page 8.

You can use the wireless remote control system with the new key. Contact your Lexus dealer for detailed information.

If your keys are locked in the vehicle and you cannot get a duplicate, many Lexus dealers can still open the door for you, using their special tools. If you must break a window to get in, we suggest breaking the smallest side window because it is the least expensive to replace. Be extremely cautious to avoid cuts from the glass.

SECTION 5

MAINTENANCE

Maintenance

Maintenance requirements	234
General maintenance	235
Does your vehicle need repairing?	238
Emissions inspection and maintenance (I/M) programs	239

For scheduled maintenance information, please refer to the “Owner’s Manual Supplement / Scheduled Maintenance”.

MAINTENANCE

MAINTENANCE REQUIREMENTS

Your Lexus vehicle has been designed for fewer maintenance requirements with longer service intervals to save both your time and money. However, each regular maintenance as well as day-to-day care is more important than ever before to ensure smooth, trouble-free, safe, and economical driving.

It is the owner's responsibility to make sure the specified maintenance, including general maintenance services, is performed. Note that both the new vehicle and emission control system warranties specify that proper maintenance and care must be performed. See "Owner's Guide", "Owner's Manual Supplement" or "Warranty Booklet" for complete warranty information.

General maintenance

General maintenance items are those day-to-day care practices that are important to your vehicle for proper operation. It is the owner's responsibility to ensure that the general maintenance items are performed regularly.

These checks or inspections can be done either by yourself or your Lexus dealer.

Scheduled maintenance

The scheduled maintenance items listed in the "Owner's Manual Supplement / Scheduled Maintenance" are those required to be serviced at regular intervals.

For details of your maintenance schedule, read the "Owner's Manual Supplement / Scheduled Maintenance".

It is recommended that only genuine Lexus parts be used for maintenance or for the repair of the emission control system.

The owner may elect to use non-Lexus supplied parts for replacement purposes without invalidating the emission control system warranty. However, use of replacement parts which are not of equivalent quality may impair the effectiveness of the emission control systems.

You may also elect to have maintenance, replacement, or repair of the emission control devices and system performed by any automotive repair establishment or individual without invalidating this warranty. See "Owner's Guide", "Owner's Manual Supplement" or "Warranty Booklet" for complete warranty information.

Where to go for service?

Lexus technicians are well-trained specialists and are kept up to date with the latest service information through technical bulletins, service tips, and in-dealership training programs. They are well informed about the operation of all the systems on your vehicle.

You can be confident that your Lexus dealer's service department performs the best job to meet the maintenance requirements of your vehicle.

Your copy of the repair order is proof that all required maintenance has been performed for warranty coverage. If any problems should arise with your vehicle while under warranty, your Lexus dealer will promptly take care of it. Again, be sure to keep a copy of the repair order for any service performed on your Lexus.

What about do-it-yourself maintenance?

Many of the maintenance items are easy to do yourself, if you have a little mechanical ability and a few basic automotive tools. Simple instructions for how to perform them are presented in Section 6.

If you are a skilled do-it-yourself mechanic, the Lexus service manuals are recommended. Please be aware that do-it-yourself maintenance can affect your warranty coverage. See "Owner's Guide", "Owner's Manual Supplement" or "Warranty Booklet" for the details.

GENERAL MAINTENANCE

Listed below are the general maintenance items that should be performed at the intervals specified. It is recommended that any problem you notice be brought to the attention of your Lexus dealer or qualified service shop for their advice.



CAUTION

Make these checks only with adequate ventilation if you run the engine.

Vehicle exterior

Items listed below should be performed from time to time, unless otherwise specified.

Tire pressure

Check the pressure with a gauge every two weeks, or at least once a month and adjust as shown on the tire pressure label. See page 282 for additional information.

Tire surface

Check the tires carefully for cuts, damage or excessive wear. See page 284 for additional information.

Wheel nuts

When checking the tires, make sure to check the nuts for looseness. Tighten them if necessary.

MAINTENANCE

Tire rotation

Rotate the tires according to the maintenance schedule. (For scheduled maintenance information, please refer to the "Owner's Manual Supplement / Scheduled Maintenance".) See page 283 for additional information.

Fluid leaks

Check underneath for leaking fuel, oil, water or other fluid after the vehicle has been parked for a while. If you smell fuel fumes or notice any leak, have the cause found and corrected immediately.

Doors and engine hood

Check that all doors, including trunk lid, operate smoothly and all latches lock securely. Make sure the engine hood secondary latch secures the hood when the primary latch is released.

Vehicle interior

Items listed below should be checked regularly, e.g. while performing periodic services, cleaning the vehicle, etc.

Lights

Make sure the headlight, stop lights, tail lights, turn signal lights, and other lights are working. Check headlight aim.

Service reminder indicators and warning buzzers

Check that all service reminder indicators and warning buzzers function properly.

Steering wheel

Check that it has the specified free play. Be alert for changes in steering condition, such as hard steering, excessive free play or strange noise.

Seats

Check that all front seat controls such as seat adjusters, seatback recliner, etc. operate smoothly. Check that the head restraints move up and down smoothly and that the locks hold securely in any latched position.

Seat belts

Check that the seat belt system such as buckles, retractors and anchors operate properly and smoothly. Make sure the belt webbing is not cut, frayed, worn or damaged.

Accelerator pedal

Check the pedal for smooth operation and uneven pedal effort or catching.

Brake pedal

Check the pedal for smooth operation and the proper clearance and free play. Check the brake booster function.

Brakes

At a safe place, check that the brakes do not pull to one side when applied.

Parking brake

Check that the lever has the proper travel and that, on a safe incline, your vehicle is held securely with only the parking brake applied.

Automatic transmission "Park" mechanism

On a safe incline, check that your vehicle is held securely with the selector lever in "P" position and all brakes released.

Engine compartment

Items listed below should be checked from time to time, e.g. each time when refueling.

Washer fluid

Make sure there is sufficient fluid in the tank. See page 303 for additional information.

Engine coolant level

Make sure the coolant level is between the Upper and Lower lines on the see-through reservoir when the engine is cold. See page 264 for additional information.

Radiator, condenser and hoses

Check that the front of the radiator and condenser are clean and not blocked with leaves, dirt, or insects. See page 266 for additional information.

Battery

Your Lexus has a maintenance free battery. You do not have to add distilled water. For longer life of the battery, however, see page 296 for additional information.

Brake fluid level

Make sure the brake fluid level is correct. See page 278 for additional information.

Engine oil level

Check the level on the dipstick with the engine turned off and the vehicle parked on a level spot. See page 260 for additional information.

MAINTENANCE

Power steering fluid level

GS430: Check the level through the reservoir. The level should be in the "HOT" or "COLD" range depending on the fluid temperature. See page 279 for additional information.

GS300: Check the level on the dipstick. The level should be in the "HOT" or "COLD" range depending on the fluid temperature. See page 280 for additional information.

Exhaust system

If you notice any change in the sound of the exhaust or smell exhaust fumes, have the cause located and corrected immediately. (See "Engine exhaust caution" on page 177.)

DOES YOUR VEHICLE NEED REPAIRING?

Be on the alert for changes in performance and sounds, and visual tip-offs that indicate service is needed. Some important clues are:

- Engine missing, stumbling, or pinging
- Appreciable loss of power
- Strange engine noises
- A fluid leak under the vehicle (however, water dripping from the air conditioning after use is normal.)
- Change in exhaust sound (This may indicate a dangerous carbon monoxide leak. Drive with the windows open and have the exhaust system checked immediately.)
- Flat-looking tires, excessive tire squeal when cornering, uneven tire wear
- Vehicle pulls to one side when driving straight on a level road
- Strange noises related to suspension movement
- Loss of brake effectiveness, spongy feeling brake pedal, pedal almost touches floors, vehicle pulls to one side when braking
- Engine coolant temperature continually higher than normal

If you notice any of these clues, take your vehicle to your Lexus dealer as soon as possible. It probably needs adjustment or repair.

 **CAUTION**

Do not continue driving with the vehicle unchecked. It could result in serious vehicle damage and possibly personal injury.

EMISSION INSPECTION AND MAINTENANCE (I/M) PROGRAMS

Some states have vehicle emission inspection programs which include OBD (On-Board Diagnostics) checks.

The OBD system monitors the operation of the emission control system. When the OBD system determines that a problem exists somewhere in the emission control system, the malfunction indicator lamp comes on. In this case, your vehicle may not pass the I/M test and need to be repaired. Contact your Lexus dealer to service the vehicle.

Even if the malfunction indicator lamp does not come on, your vehicle may not pass the I/M test as readiness codes have not been set in the OBD system.

Readiness codes are automatically set during ordinary driving. However, when the battery is disconnected or run down, the codes are erased. Also, depending on your driving habits, the codes may not be completely set.

Also, if the malfunction indicator lamp had come on recently due to temporary malfunction such as a loose fuel tank cap, your vehicle may not pass the I/M test.

The malfunction indicator lamp will go off after taking several driving trips, but the error code in the OBD system will not be cleared unless about 40 trips or more are taken.

If your vehicle does not pass the I/M test and the malfunction indicator lamp does not come on, contact your Lexus dealer to prepare the vehicle for re-testing.

SECTION 6-1

SERVICE PROCEDURES AND SPECIFICATIONS

Introduction

Vehicle identification	242
Engine compartment overview (GS430)	243
Engine compartment overview (GS300)	244
Do-it-yourself service precautions	245
Positioning the jack	246
Parts and tools	247

INTRODUCTION

VEHICLE IDENTIFICATION



The vehicle identification number (VIN) is the legal identifier for your vehicle. This number is on the left top of the instrument panel and can be seen through the windshield from outside.

This is the primary identification number for your Lexus. It is used in registering the ownership of your vehicle.



The vehicle identification number (VIN) is also on the Certification Label.

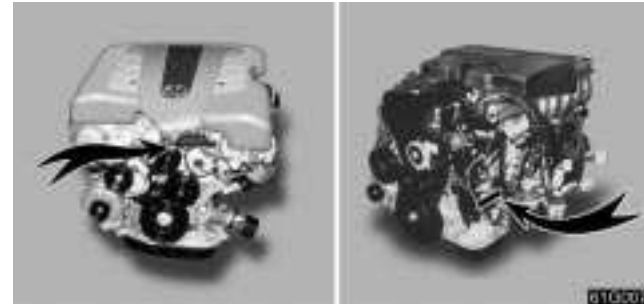

▶ **GS430**

▶ **GS300**

The engine number is stamped on the engine block as shown.

ENGINE COMPARTMENT OVERVIEW (GS430)

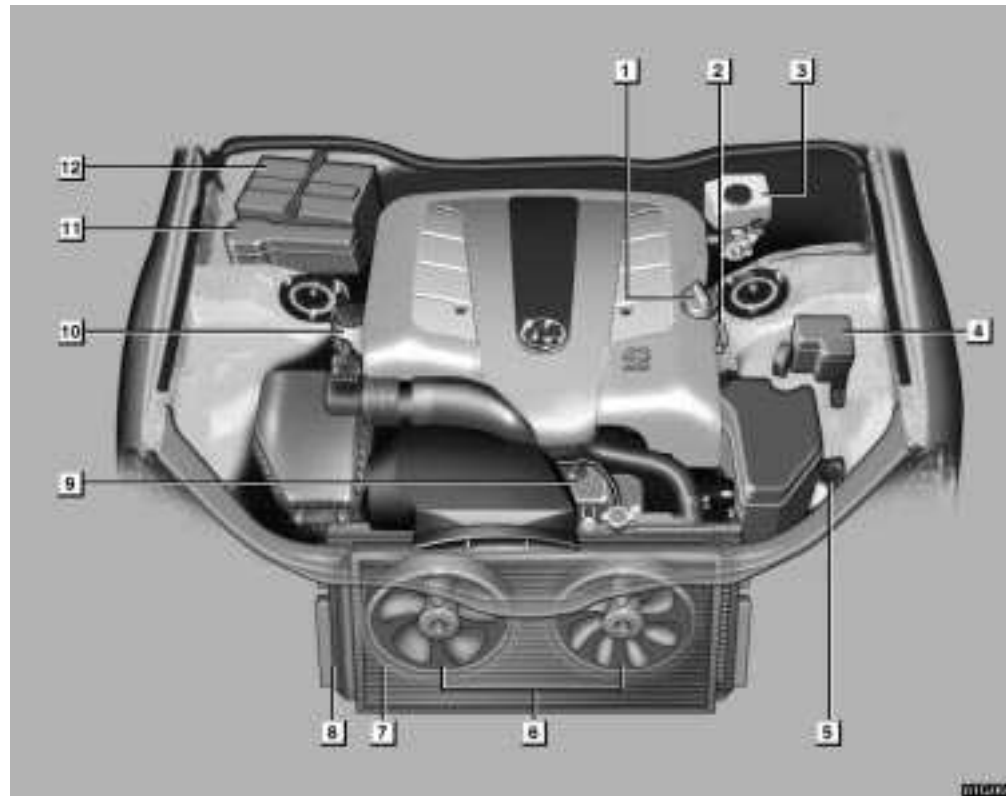

- 1** *Engine oil filler cap*
- 2** *Engine oil level dipstick*
- 3** *Brake fluid reservoir*
- 4** *Fuse box*
- 5** *Washer fluid tank*
- 6** *Electric cooling fans*
- 7** *Condenser*
- 8** *Radiator*
- 9** *Engine coolant reservoir*
- 10** *Power steering fluid reservoir*
- 11** *Fuse box*
- 12** *Battery*

ENGINE COMPARTMENT OVERVIEW (GS300)

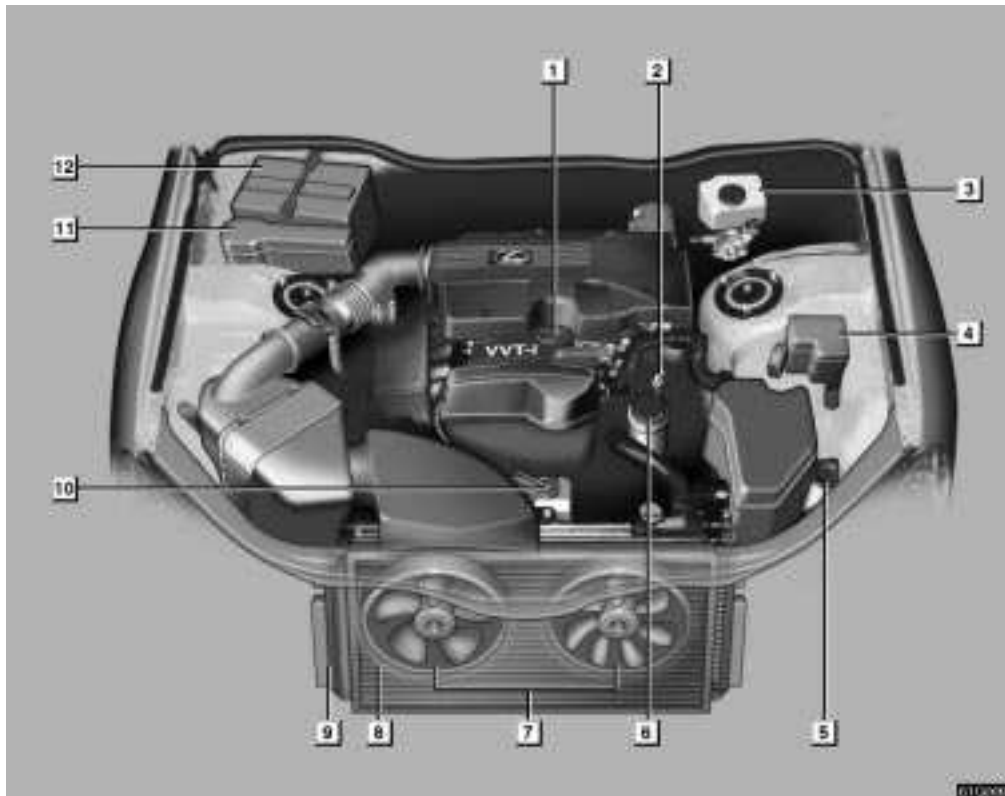

- 1 Engine oil filler cap
- 2 Engine oil level dipstick
- 3 Brake fluid reservoir
- 4 Fuse box
- 5 Washer fluid tank
- 6 Power steering fluid reservoir
- 7 Electric cooling fans
- 8 Condenser
- 9 Radiator
- 10 Engine coolant reservoir
- 11 Fuse box
- 12 Battery

DO-IT-YOURSELF SERVICE PRECAUTIONS

If you perform maintenance yourself, be sure to follow the correct procedure given in this Section.

You should be aware that improper or incomplete servicing may result in operating problems.

Performing do-it-yourself maintenance during the warranty period may affect your warranty coverage. Read the separate Lexus Warranty statement for details and suggestions.

This Section gives instructions only for those items that are relatively easy for an owner to perform. As explained in Section 5, there are still a number of items that must be performed by a qualified technician with special tools.

For information on tools and parts for do-it-yourself maintenance, see "Parts and tools" on page 247.

Utmost care should be taken when working on your vehicle to prevent accidental injury. Here are a few precautions that you should be especially careful to observe:



CAUTION

- When the engine is running, keep hands, clothing, and tools away from the moving fan and engine drive belt. (Removing rings, watches, and ties is advisable.)
- Right after driving, the engine compartment – the engine, radiator, exhaust manifold and power steering fluid reservoir, etc. – will be hot. So be careful not to touch them. Oil and other fluids may also be hot.
- Do not smoke, cause sparks or allow open flames around fuel or the battery. Their fumes are flammable.
- Do not get under your vehicle with just the body jack supporting it. Always use automotive jack stands or other solid supports.
- Be sure the ignition is off if you work near the electric cooling fan or radiator grille. With the ignition on, the electric cooling fan may automatically start to run if the air conditioning is on and/or if the coolant temperature is high.
- Use eye protection whenever you work on or under your vehicle where you may be exposed to flying or falling material, fluid spray, etc.
- Be extremely cautious when working on the battery. It contains poisonous and corrosive sulfuric acid.

INTRODUCTION

- **Warning:** Battery posts, terminals and related accessories contain lead and lead compounds, chemicals known to the State of California to cause cancer and reproductive harm. Wash hands after handling.

NOTICE

- *Remember that battery and ignition cables carry high currents or voltages. Be careful of accidentally causing a short circuit.*
- *Before closing the engine hood, check to see that you have not forgotten any tools, rags, etc.*
- *Do not drive with the air cleaner removed, or excessive engine wear could result. Also backfiring could cause a fire in the engine compartment.*
- *Do not overfill automatic transmission fluid, or the transmission could be damaged.*
- *Be careful not to scratch the glass surface with the wiper frame.*

POSITIONING THE JACK



► Front



► Rear

When jacking up your vehicle with the jack, position the jack correctly as shown in the illustrations.

⚠ CAUTION

When jacking, be sure to observe the following to reduce the possibility of personal injury:

- Follow jacking instructions.
- Do not put any part of your body under the vehicle supported by the jack. Personal injury may occur.
- Do not start or run the engine while your vehicle is supported by the jack.
- Stop the vehicle on a level firm ground, firmly set the parking brake and put the transmission in “P” position.
- Make sure to set the jack properly in the jack point. Raising the vehicle with jack improperly positioned will damage the vehicle or may allow the vehicle to fall off the jack and cause personal injury.
- Never get under the vehicle when the vehicle is supported by the jack alone; use vehicle support stands.
- Do not raise the vehicle with someone in the vehicle
- When raising the vehicle, do not place any objects on top of or underneath the jack.

NOTICE

Make sure to place the jack correctly, or your vehicle may be damaged.

PARTS AND TOOLS

Here is a list of parts and tools you will need to perform do-it-yourself maintenance. Remember all Lexus parts are designed in metric sizes, so your tools must be metric.

Checking the engine oil level**Parts (if level is low):**

- “Toyota Genuine Motor Oil” or equivalent
Oil grade: API grade SL “Energy-Conserving” or ILSAC multigrade engine oil. For recommended oil viscosity, see page 263.

Tools:

- Rag or paper towel
- Funnel (only for adding oil)

Checking the engine coolant level**Parts (if level is low):**

- “Toyota Genuine Long Life Coolant” or equivalent
See “Checking the engine coolant level” on page 264 for instructions.
- Demineralized or distilled water

Tools:

- Funnel (only for adding coolant)

INTRODUCTION

Checking brake fluid

Parts (if level is low):

- FMVSS No. 116 DOT 3 or SAE J1703 brake fluid

Tools:

- Funnel (only for adding fluid)

Checking power steering fluid

Parts (if level is low):

- Automatic transmission fluid DEXRON® II or III

Tools:

- Rag or paper towel
- Funnel (only for adding fluid)

Checking battery condition

Tools:

- Warm water
- Baking soda
- Grease
- Conventional wrench (for terminal clamp bolts)

Checking and replacing the blade type fuses

Parts (if replacement is necessary):

- Fuse with same amperage rating as original

Checking the cartridge type fuses

Parts (if replacement is necessary):

- Genuine Lexus fuse or equivalent with same amperage rating as original

Adding washer fluid

Parts:

- Water
- Washer fluid containing antifreeze (for winter use)

Tools:

- Funnel

SECTION 6-2

SERVICE PROCEDURES AND SPECIFICATIONS

Engine

Specifications (GS430)	250
Specifications (GS300)	253
Fuel	256
Fuel pump shut off system	258
Facts about engine oil consumption	258
Used engine oil	260
Checking the engine oil level	260
Checking the engine coolant level	264
Checking the radiator and condenser	266
Spark plugs	267

ENGINE

SPECIFICATIONS (GS430)

– GENERAL

Model	3UZ-FE
Type	8 cylinder V type, 4 cycle, gasoline
Bore and stroke	91.0 X 82.5 mm (3.58 X 3.25 in.)
Displacement	4293 cm ³ (261.9 cu.in.)
Valve clearance (engine cold) Intake Exhaust	0.15 – 0.25 mm (0.006 – 0.010 in.) 0.25 – 0.35 mm (0.010 – 0.014 in.)
Drive belt tension	Automatic adjustment

– FUEL

Fuel type	Only UNLEADED
Octane rating	91 (Research octane number 96) or higher

- LUBRICATION SYSTEM

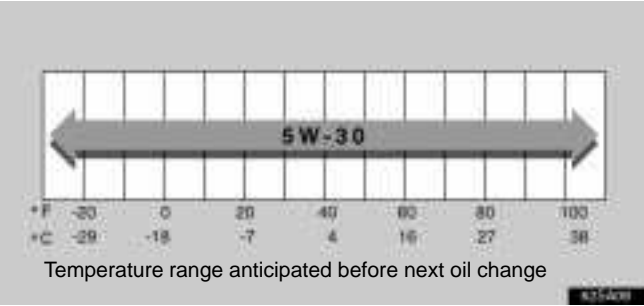
<p>Oil capacity Drain and refill with filter without filter</p>	<p>5.2 L (5.5 qt., 4.6 Imp.qt.) 4.9 L (5.2 qt., 4.3 Imp.qt.)</p>
<p>Oil grade</p>	<p>API grade SL "Energy-Conserving" or ILSAC multigrade engine oil</p>
<p>Recommended oil viscosity</p>	<p>5W-30</p>  <p>Temperature range anticipated before next oil change</p>

NOTE:

"Toyota Genuine Motor Oil" is filled in your Lexus vehicle. Use Lexus approved "Toyota Genuine Motor Oil" or equivalent to satisfy the above grade and viscosity. Please contact your Lexus dealer for further details.

ENGINE

– COOLING SYSTEM

Capacity	9.0 L (9.5 qt., 7.9 Imp.qt.)
Coolant type	“Toyota Genuine Long Life Coolant” or equivalent With ethylene–glycol type coolant for a proper corrosion protection of aluminum components Do not use alcohol type antifreeze or plain water alone.

NOTE:

“Toyota Genuine Long Life Coolant” is filled in your Lexus vehicle. In order to avoid technical problems, we strongly recommend using “Toyota Genuine Long Life Coolant” or equivalent. Please contact your Lexus dealer for further details.

– IGNITION SYSTEM

Spark plug – Make	DENSO NGK	SK20R11 IFR6A11
– Gap		1.1 mm (0.043 in.)

– ELECTRICAL SYSTEM

Battery – Open voltage at 20°C (68°F):	12.7V Fully charged 12.3V Half charged 11.9V Discharged [Voltage that is checked 20 minutes after the key is removed with all the lights turned off]
– Charging rates	5A max.

SPECIFICATIONS (GS300)**– GENERAL**

Model	2JZ–GE
Type	6 cylinder in line, 4 cycle, gasoline
Bore and stroke	86.0 X 86.0 mm (3.39 X 3.39 in.)
Displacement	2997 cm ³ (182.9 cu.in.)
Valve clearance (engine cold) Intake Exhaust	0.15 – 0.25 mm (0.006 – 0.010 in.) 0.25 – 0.35 mm (0.010 – 0.014 in.)
Drive belt tension	Automatic adjustment

– FUEL

Fuel type	Only UNLEADED
Octane rating	91 (Research octane number 96) or higher

ENGINE

– LUBRICATION SYSTEM

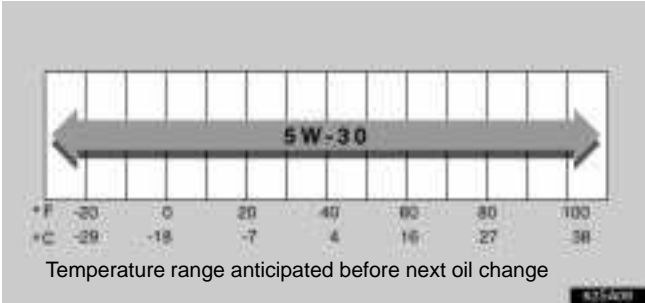
Oil capacity Drain and refill with filter without filter	5.4 L (5.7 qt., 4.8 Imp.qt.) 5.1 L (5.4 qt., 4.5 Imp.qt.)
Oil grade	API grade SL “Energy-Conserving” or ILSAC multigrade engine oil
Recommended oil viscosity	5W-30 

NOTE:

“Toyota Genuine Motor Oil” is filled in your Lexus vehicle. Use Lexus approved “Toyota Genuine Motor Oil” or equivalent to satisfy the above grade and viscosity. Please contact your Lexus dealer for further details.

– COOLING SYSTEM

Capacity	7.7 L (8.1 qt., 6.8 Imp.qt.)
Coolant type	“Toyota Genuine Long Life Coolant” or equivalent With ethylene–glycol type coolant for a proper corrosion protection of aluminum components Do not use alcohol type antifreeze or plain water alone.

NOTE:

“Toyota Genuine Long Life Coolant” is filled in your Lexus vehicle. In order to avoid technical problems, we strongly recommend using “Toyota Genuine Long Life Coolant” or equivalent. Please contact your Lexus dealer for further details.

– IGNITION SYSTEM

Spark plug – Make DENSO – Gap	SK16R–P11 1.1 mm (0.043 in.)
----------------------------------	---------------------------------

– ELECTRICAL SYSTEM

Battery – Open voltage at 20°C (68°F):	12.7V Fully charged 12.3V Half charged 11.9V Discharged [Voltage that is checked 20 minutes after the key is removed with all the lights turned off]
– Charging rates	5A max.

ENGINE

FUEL

Fuel type

Your vehicle must use only unleaded gasoline.

To help prevent gas station mixups, your Lexus has a smaller fuel tank opening. The special nozzle on pumps with unleaded fuel will fit it, but the larger standard nozzle on pumps with leaded gas will not.

At a minimum, the gasoline you use should meet the specifications of ASTM D4814 in the U.S.A. and CGSB 3.5-M93 in Canada.

NOTICE

Do not use leaded gasoline. Use of leaded gasoline will cause the three-way catalytic converter to lose its effectiveness and the emission control system to function improperly. Also, this can increase maintenance costs.

Octane rating

Select premium unleaded gasoline with an Octane Rating of 91 (Research Octane Number 96) or higher for optimum engine performance. However, if such premium type cannot be obtained, you may temporarily use unleaded gasoline with an Octane Rating as low as 87 (Research Octane Number 91).

Use of unleaded fuel with an octane number or rating lower than stated above will cause persistent heavy knocking. If severe, this will lead to engine damage.

If your engine knocks ...

If you detect heavy knocking even when using the recommended fuel, or if you hear steady knocking while holding a steady speed on level roads, consult your Lexus dealer.

However, occasionally, you may notice light knocking for a short time while accelerating or driving up hills. This is normal and there is no need for concern.

Gasoline containing detergent additives

Lexus recommends the use of gasoline that contains detergent additives to avoid build-up of engine deposits.

However, all gasoline sold in the U.S. contains detergent additives to keep clean and/or clean intake systems.

Quality gasoline

Automotive manufacturers in the U.S., Europe and Japan have developed a specification for quality fuel named World-Wide Fuel Charter (WWFC) that is expected to be applied world wide. The WWFC consists of three categories that depend on required emission levels. In the U.S., category 3 has been adopted. The WWFC improves air quality by providing for better emissions in vehicle fleets, and customer satisfaction through better vehicle performance.

Cleaner burning gasoline

Cleaner burning gasoline, including reformulated gasoline that contains oxygenates such as ethanol or MTBE is available in many areas.

Lexus recommends the use of cleaner burning gasoline and appropriately blended reformulated gasoline. These types of gasoline provide excellent vehicle performance, reduce vehicle emissions, and improve air quality.

Oxygenates in gasoline

Lexus allows the use of oxygenate blended gasoline where the oxygenate content is up to 10% ethanol or 15% MTBE. If you use gasohol in your Lexus, be sure that it has an octane rating no lower than 87.

Lexus does not recommend the use of gasoline containing methanol.

Gasoline containing MMT

Some gasoline contain an octane enhancing additive called MMT (Methylcyclopentadienyl Manganese Tricarbonyl).

Lexus does not recommend the use of gasoline that contains MMT. If fuel containing MMT is used, your emission control system may be adversely affected. The Malfunction Indicator Lamp on the instrument cluster may come on. If this happens, contact your Lexus dealer for service.

Gasoline quality

In a very few cases, you may experience driveability problems caused by the particular gasoline that you are using. If you continue to have unacceptable driveability, try changing gasoline brands. If this does not rectify your problem, then consult your Lexus dealer.

NOTICE

- ***Do not use gasohol other than stated above. It will cause fuel system damage or vehicle performance problems.***
- ***If drivability problems are encountered (poor hot starting, vaporizing, engine knock, etc.), discontinue its use.***
- ***Take care not to spill gasohol during refueling. Gasohol may cause paint damage.***

Fuel tank capacity

75 L (19.8 gal., 16.5 Imp.gal.)

ENGINE

FUEL PUMP SHUT OFF SYSTEM

The fuel pump shut off system stops supplying fuel to the engine to minimize the risk of fuel leakage when the engine stalls or an airbag inflates upon collision. To restart the engine after the fuel pump shut off system activates, turn the ignition switch to "ACC" or "LOCK" once and start it.



CAUTION

Inspect the ground under the vehicle before restarting the engine. If you find that liquid has leaked onto the ground, it is the fuel system that has been damaged and it is in need of repair. In this case, do not restart the engine.

FACTS ABOUT ENGINE OIL CONSUMPTION

Functions of engine oil

Engine oil has the primary function of lubricating and cooling the inside of the engine, and plays a major role in maintaining the engine in proper working order.

Engine oil consumption

It is normal that an engine should consume some engine oil during normal engine operation. The causes of oil consumption in a normal engine are as follows.

- Oil is used to lubricate pistons, piston rings and cylinders. A thin film of oil is left on the cylinder wall when a piston moves downwards in the cylinder. High negative pressure generated when the vehicle is decelerating sucks some of this oil into the combustion chamber. This oil as well as some part of the oil film left on the cylinder wall is burned by the high temperature combustion gases during the combustion process.
- Oil is also used to lubricate the stems of the intake valves. Some of this oil is sucked into the combustion chamber together with the intake air and is burned along with the fuel. High temperature exhaust gases also burn the oil used to lubricate the exhaust valve stems.

The amount of engine oil consumed depends on the viscosity of the oil, the quality of the oil and the way the vehicle is driven.

More oil is consumed under driving conditions such as high speeds and frequent acceleration and deceleration.

A new engine consumes more oil, since its pistons, piston rings and cylinder walls have not become conditioned.

Oil consumption: Max. 1.0 L per 1000 km (1.1 qt./600 miles, 0.9 Imp-qt./600 miles).

When judging the amount of oil consumption, keep in mind that the oil may have become diluted, making it difficult to judge the true level accurately.

For example, if a vehicle is used for repeated short trips and consumes a normal amount of oil, the dipstick may not show any drop in the oil level at all, even after 1000 km (600 miles) or more. This is because the oil is gradually becoming diluted with fuel or moisture, making it appear that the oil level has not changed.

The diluting ingredients evaporate out when the vehicle is then driven at high speeds, as on an expressway, making it appear that oil is excessively consumed after driving at high speeds.

Importance of engine oil level check

One of the most important points in proper vehicle maintenance is to keep the engine oil at the optimum level so that oil function will not be impaired. Therefore, it is essential that the oil level be checked regularly. Lexus recommends that the oil level be checked every time you refuel the vehicle.

NOTICE

Failure to check the oil level regularly could lead to serious engine trouble due to insufficient oil.

For detailed information on oil level check, see "Checking the engine oil level" on page 260.

ENGINE

USED ENGINE OIL

CAUTION

- Used engine oil contains potentially harmful contaminants which may cause skin disorders such as inflammation or skin cancer, so care should be taken to avoid prolonged and repeated contact with it. To remove used engine oil from your skin, wash thoroughly with soap and water.
- Do not leave used oil within the reach of children.
- Dispose of used oil and used oil filters only in a safe and acceptable manner. Do not dispose of used oil and used oil filters in household trash, in sewers or onto the ground. Call your Lexus dealer or a service station for information concerning recycling or disposal.

CHECKING THE ENGINE OIL LEVEL



► **GS430**

► **GS300**

With the engine at operating temperature and turned off, check the oil level on the dipstick.

1. To get a true reading, the vehicle should be on a level ground. After turning off the engine, wait a few minutes for the oil to drain back into the bottom of the engine.
2. Pull the dipstick out, hold a rag under the end and wipe it clean.
3. Reinsert the dipstick and push it in as far as it will go, or the reading will not be correct.

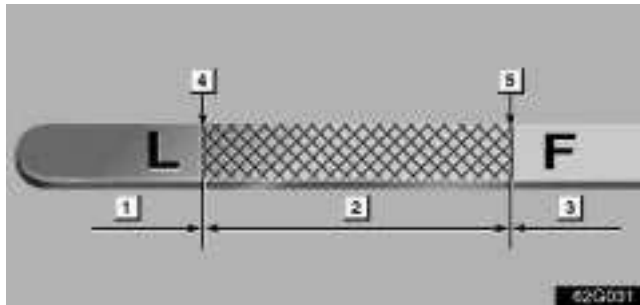

► **GS430** **1** Add oil **2** O.K. **3** Too full

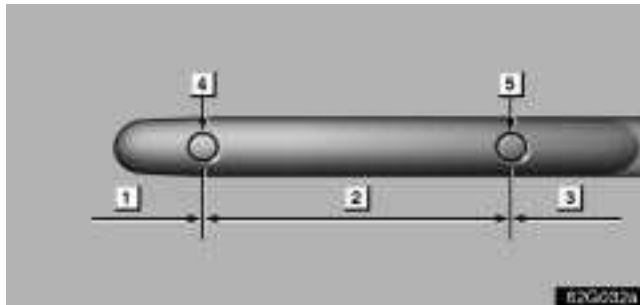

► **GS300** **1** Add oil **2** O.K. **3** Too full

4. Pull the dipstick out and look at the oil level while holding a rag under the end. If it is between the full line (**5**) and the low line (**4**), it is O.K.

NOTICE

Be careful not to drop the engine oil on the vehicle components.

ENGINE



► **GS430**

► **GS300**

If the oil level is below or only slightly above the low level mark, add engine oil of the same type as already in the engine.

Remove the oil filler cap and add engine oil a little at a time, checking the dipstick. We recommend that you use a funnel when adding oil. The approximate quantity of oil needed to fill between the low level mark and the full level mark on the dipstick is indicated below for reference.

When the level reaches within the correct range, return the filler cap and turn the cap clockwise until you hear a click.

Oil quantity. L (qt., Imp. qt.) 1.8 (1.9, 1.6)

NOTICE

- **Be careful not to spill the engine oil on the vehicle components.**
- **Avoid overfilling, or the engine could be damaged.**
- **Check the oil level on the dipstick once again after adding the oil.**

Engine oil selection

"Toyota Genuine Motor Oil" is filled in your Lexus vehicle. Use Lexus approved "Toyota Genuine Motor Oil" or equivalent to satisfy the following grade and viscosity.

Oil grade: API grade SL "Energy-Conserving" or ILSAC multigrade engine oil.

Recommended viscosity: 5W-30

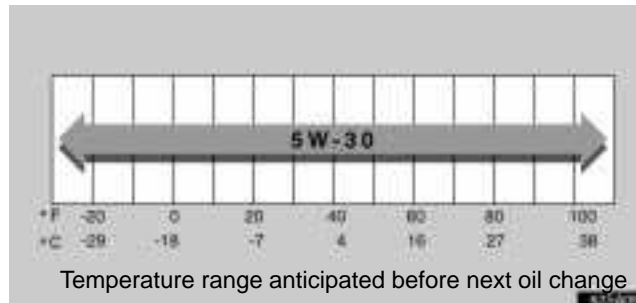

SAE 5W-30 is the best choice for good fuel economy, and good starting in cold weather.

If SAE is not available, SAE10W-30 may be used. However, it should be replaced with 5W-30 at the next oil change.

Oil identification marks



► **API Service Symbol**

► **ILSAC Certification Mark**

Either or both API registered marks are added to some oil containers to help you select the oil you should use.

- The API Service Symbol is located anywhere on the outside of the container.
The top portion of the label shows the oil quality by API (American Petroleum Institute) designation such as SL. The center portion of the label shows the SAE viscosity grade such as SAE 5W-30. "Energy-Conserving", shown in the lower portion, indicates that the oil has fuel-saving capabilities.
- The ILSAC (International Lubricant Standardization and Approval Committee) Certification Mark is displayed on the front of the container.

ENGINE

To ensure excellent performance for your engine, "Toyota Genuine Motor Oil" is available, which has been specifically tested and approved for all Lexus engines.

Please contact your Lexus dealer for further details about "Toyota Genuine Motor Oil".

CHECKING THE ENGINE COOLANT LEVEL

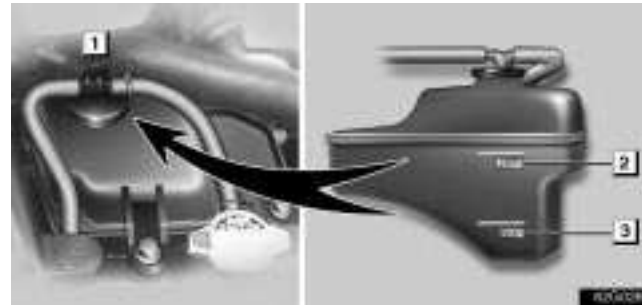

► **GS430** 1 Reservoir cap 2 Upper line 3 Lower line



► **GS300** 1 Reservoir cap 2 Upper line 3 Lower line

Look at the see-through coolant reservoir when the engine is cold. The coolant level is satisfactory if it is between the "FULL" and "LOW" lines on the reservoir. If the level is low, add ethylene-glycol type coolant for a proper corrosion protection of aluminum components.

The coolant level in the reservoir will vary with engine temperature. However, if the level is on or below the "LOW" line, add coolant. Bring the level up to the "FULL" line.

Always use ethylene-glycol type coolant for a proper corrosion protection of aluminum components. See information in the next column.

If the coolant level drops within a short time after replenishing, there may be a leak in the system. Visually check the radiator, hoses, engine coolant filler cap, radiator cap and drain cock and water pump.

If you can find no leak, have your Lexus dealer test the cap pressure and check for leaks in the cooling system.

 **CAUTION**

To prevent burning yourself, do not remove the radiator cap when the engine is hot.

Coolant type selection

Use of improper coolants may damage your engine cooling system. Your coolant must contain ethylene-glycol type coolant for proper corrosion protection of your engine that contains aluminum components. We have used "Toyota Genuine Long Life Coolant" in your Lexus vehicle. In order to avoid technical problems, we strongly recommend using "Toyota Genuine Long Life Coolant" or equivalent.

In addition to preventing freezing and subsequent damage to the engine, this type of coolant will also prevent corrosion. Further supplemental inhibitors or additives are neither needed nor recommended.

Read the coolant container for information on freeze protection. Follow the manufacturer's directions for how much to mix with plain water (preferably demineralized water or distilled water). The total capacity of the cooling system is given on page 252 or 255.

We recommend a 50% solution for your Lexus, to provide protection down to about -35°C (-31°F). When it is extremely cold, to provide protection down to about -50°C (-58°F), a 60% solution is recommended. Do not use more than 70% solution for better coolant performance.

NOTICE

Do not use alcohol type antifreeze or plain water alone.

ENGINE

The engine cooling system is integral to maximizing performance of your Lexus vehicle. In line with this, it is strongly recommended that you use "Toyota Genuine Long Life Coolant" for protecting the system, as it is an ethylene-glycol based premium antifreeze coolant with excellent corrosion protection properties that has been specifically formulated for use in Lexus vehicles.

Please contact your Lexus dealer for further details about "Toyota Genuine Long Life Coolant".

CHECKING THE RADIATOR AND CONDENSER

If either of the above parts are extremely dirty or you are not sure of their condition, take your vehicle to your Lexus dealer.

CAUTION

To prevent burning yourself , be careful not to touch the radiator or condenser when the engine is hot.

NOTICE

To prevent damage to the radiator and condenser, do not perform the work by yourself.

SPARK PLUGS



► GS430

Your engine is fitted with iridium-tipped spark plugs.

NOTICE

Use only iridium-tipped spark plugs and do not adjust gaps for your engine performance and smooth drivability.



► GS300

Your engine is fitted with the designated iridium-tipped spark plugs.

NOTICE

Use the designated iridium-tipped spark plugs and do not adjust gaps for your engine performance and smooth drivability.

SECTION 6-3

SERVICE PROCEDURES AND SPECIFICATIONS

Chassis

Specifications (GS430)	270
Specifications (GS300)	274
Checking brake fluid	278
Checking power steering fluid (GS430)	279
Checking power steering fluid (GS300)	280
Checking tire pressure	282
Rotating tires	283
Checking and replacing tires	284
Installing snow tires and chains	287
Replacing wheels	288
Aluminum wheel precautions	289
Suspension and chassis	290

CHASSIS

SPECIFICATIONS (GS430)

– DIFFERENTIAL

Oil capacity		1.35 L (1.42 qt., 1.19 Imp.qt.)
Oil type and viscosity	Vehicles without synthetic oil information label	Hypoid gear oil API GL-5 Above -18°C (0°F): SAE 90 Below -18°C (0°F): SAE 80W or SAE 80W-90
	Vehicles with synthetic oil information label*	Toyota Genuine Differential Synthetic gear oil API GL-5 SAE 75W-90 or its equivalent

NOTE:

***Vehicles with synthetic oil information label only:**
The following label is affixed on the right side of the differential carrier. Use the type and viscosity shown on the label when the differential oil is replaced.

SYNTHETIC ONLY SAE 75W-90 API GL-5

Synthetic oil information label

NOTICE

Vehicles with synthetic oil information label only:
Use of differential oil other than “Toyota Genuine Differential Synthetic gear oil API GL-5 SAE 75W-90” or its equivalent may damage the differential gear of your vehicle and diminish fuel efficiency. For the reasons mentioned above, Lexus recommends use of “Toyota Genuine Differential Synthetic gear oil API GL-5 SAE 75W-90”.
Another differential oil of matching quality can also be used, (but note that despite the similarity in nomenclature between “Toyota Genuine Differential Synthetic gear oil API GL-5 SAE 75W-90” and oils that meet SAE 75W-90 specifications, compliance with the SAE specification does not guarantee that an oil has all characteristic required to avoid the problem described above.) If you are unable to locate an equivalent to “Toyota Genuine Differential Synthetic gear oil API GL-5 SAE 75W-90”, contact your Lexus dealer for further details or another duly qualified and equipped professional.

– AUTOMATIC TRANSMISSION

Fluid capacity Drain and refill	1.8 L (1.9 qt., 1.6 Imp.qt.)
Fluid type	Toyota Genuine ATF Type T – IV*

*Change automatic transmission fluid only as necessary. Generally, it is necessary to change automatic transmission fluid only if your vehicle is driven under one of the Special Operating Conditions listed in your “Owner’s Manual Supplement / Scheduled Maintenance”. When changing the automatic transmission fluid, use only “Toyota Genuine ATF Type T–IV” (ATF JWS3309 or NWS6500) to aid in assuring optimum transmission performance.

NOTICE

Using automatic transmission fluid other than “Toyota Genuine ATF Type T–IV” may cause deterioration in shift quality, locking up of your transmission accompanied by vibration, and ultimately damage the automatic transmission of your vehicle.

– BRAKES

Pedal clearance *1	93 mm (3.7 in.) Min.
Pedal free play	0.2 – 2 mm (0.008 – 0.08 in.)
Brake pad wear limit	1.0 mm (0.04 in.)
Parking brake lining wear limit	1.0 mm (0.04 in.)
Parking brake adjustment *2	7 – 9 clicks
Fluid type	SAE J1703 or FMVSS No. 116 DOT 3

*1Minimum pedal clearance when depressed with the force of 196 N (20 kgf, 44 lbf.) with the engine running

*2Parking brake adjustment when depressed with the force of 294 N (30 kgf, 66.1 lbf.)

CHASSIS

– STEERING

Free play	Less than 30 mm (1.2 in.)
Power steering fluid	Automatic transmission fluid DEXRON®II or III

– TIRES AND WHEELS (Type A)

Tire size	225/55R16 94V
Tire inflation pressure Recommended cold tire inflation pressure 225/55R16 94V	Front 220 kPa (2.2 kgf/cm ² or bar, 32 psi) Rear 220 kPa (2.2 kgf/cm ² or bar, 32 psi) For sustained high speeds above 160 km/h (100 mph), in countries where such speeds are permitted by law, add 80 kPa (0.8 kgf/cm ² or bar, 12 psi) to the front tires and rear tires, but never exceed the maximum cold tire pressure molded on the tire sidewall.
Wheel size	16 x 7 1/2 JJ
Wheel nut torque	103 N·m (10.5 kgf·m, 76 ft·lbf.)

NOTE:

For complete information on tires (e.g. replacing tires or replacing wheels), see “Checking tire pressure” through “Aluminum wheel precautions” on page 282 through 289.

- TIRES AND WHEELS (Type B)

Tire size	235/45ZR17
Tire inflation pressure Recommended cold tire inflation pressure 235/45ZR17	Front 230 kPa (2.3 kgf/cm ² or bar, 33 psi) Rear 230 kPa (2.3 kgf/cm ² or bar, 33 psi) For sustained high speeds above 160 km/h (100 mph), in countries where such speeds are permitted by law, add 70 kPa (0.7 kgf/cm ² or bar, 10 psi) to the front tires and rear tires, but never exceed the maximum cold tire pressure molded on the tire sidewall.
Wheel size	17 x 8 JJ
Wheel nut torque	103 N·m (10.5 kgf·m, 76 ft·lbf.)

NOTE:

For complete information on tires (e.g. replacing tires or replacing wheels), see "Checking tire pressure" through "Aluminum wheel precautions" on page 282 through 289.

CHASSIS

SPECIFICATIONS (GS300)

– DIFFERENTIAL

Oil capacity		1.35 L (1.42 qt., 1.19 Imp.qt.)
Oil type and viscosity	Vehicles without synthetic oil information label	Hypoid gear oil API GL-5 Above -18°C (0°F): SAE 90 Below -18°C (0°F): SAE 80W or SAE 80W-90
	Vehicles with synthetic oil information label*	Toyota Genuine Differential Synthetic gear oil API GL-5 SAE 75W-90 or its equivalent

NOTE:

***Vehicles with synthetic oil information label only:**
The following label is affixed on the right side of the differential carrier. Use the type and viscosity shown on the label when the differential oil is replaced.

SYNTHETIC ONLY SAE 75W-90 API GL-5

Synthetic oil information label

NOTICE

Vehicles with synthetic oil information label only:
Use of differential oil other than "Toyota Genuine Differential Synthetic gear oil API GL-5 SAE 75W-90" or its equivalent may damage the differential gear of your vehicle and diminish fuel efficiency. For the reasons mentioned above, Lexus recommends use of "Toyota Genuine Differential Synthetic gear oil API GL-5 SAE 75W-90". Another differential oil of matching quality can also be used, (but note that despite the similarity in nomenclature between "Toyota Genuine Differential Synthetic gear oil API GL-5 SAE 75W-90" and oils that meet SAE 75W-90 specifications, compliance with the SAE specification does not guarantee that an oil has all characteristic required to avoid the problem described above.) If you are unable to locate an equivalent to "Toyota Genuine Differential Synthetic gear oil API GL-5 SAE 75W-90", contact your Lexus dealer for further details or another duly qualified and equipped professional.

– AUTOMATIC TRANSMISSION

Fluid capacity Drain and refill	2.0 L (2.1 qt., 1.8 Imp.qt.)
Fluid type	Toyota Genuine ATF Type T – IV*

*Change automatic transmission fluid only as necessary. Generally, it is necessary to change automatic transmission fluid only if your vehicle is driven under one of the Special Operating Conditions listed in your “Owner’s Manual Supplement / Scheduled Maintenance”. When changing the automatic transmission fluid, use only “Toyota Genuine ATF Type T–IV” (ATF JWS3309 or NWS6500) to aid in assuring optimum transmission performance.

NOTICE

Using automatic transmission fluid other than Toyota Genuine ATF Type T–IV may cause deterioration in shift quality, locking up of your transmission accompanied by vibration, and ultimately damage the automatic transmission of your vehicle.

– BRAKES

Pedal clearance *1	93 mm (3.7 in.) Min.
Pedal free play	0.2 – 2 mm (0.008 – 0.08 in.)
Brake pad wear limit	1.0 mm (0.04 in.)
Parking brake lining wear limit	1.0 mm (0.04 in.)
Parking brake adjustment *2	7 – 9 clicks
Fluid type	SAE J1703 or FMVSS No. 116 DOT 3

*1Minimum pedal clearance when depressed with the force of 196 N (20 kgf, 44 lbf.) with the engine running

*2Parking brake adjustment when depressed with the force of 294 N (30 kgf, 66.1 lbf.)

CHASSIS

– STEERING

Free play	Less than 30 mm (1.2 in.)
Power steering fluid	Automatic transmission fluid DEXRON® II or III

– TIRES AND WHEELS (Type A)

Tire size	P215/60R16 94V
Tire inflation pressure Recommended cold tire inflation pressure P215/60R16 94V	Front 210 kPa (2.1 kgf/cm ² or bar, 30 psi) Rear 210 kPa (2.1 kgf/cm ² or bar, 30 psi) For sustained high speeds above 160 km/h (100 mph), in countries where such speeds are permitted by law, add 90 kPa (0.9 kgf/cm ² or bar, 13 psi) to the front tires and rear tires, but never exceed the maximum cold tire pressure molded on the tire sidewall.
Wheel size	16 x 7 1/2 JJ
Wheel nut torque	103 N·m (10.5 kgf·m, 76 ft·lbf.)

NOTE:

For complete information on tires (e.g. replacing tires or replacing wheels), see “Checking tire pressure” through “Aluminum wheel precautions” on page 282 through 289.

- TIRES AND WHEELS (Type B)

Tire size	225/55R16 94V
Tire inflation pressure Recommended cold tire inflation pressure 225/55R16 94V	Front 220 kPa (2.2 kgf/cm ² or bar, 32 psi) Rear 220 kPa (2.2 kgf/cm ² or bar, 32 psi) For sustained high speeds above 160 km/h (100 mph), in countries where such speeds are permitted by law, add 80 kPa (0.8 kgf/cm ² or bar, 12 psi) to the front tires and rear tires, but never exceed the maximum cold tire pressure molded on the tire sidewall.
Wheel size	16 x 7 1/2 JJ
Wheel nut torque	103 N·m (10.5 kgf·m, 76 ft·lbf.)

NOTE:

For complete information on tires (e.g. replacing tires or replacing wheels), see "Checking tire pressure" through "Aluminum wheel precautions" on page 282 through 289.

CHASSIS

CHECKING BRAKE FLUID



To check the fluid level, simply look at the see-through reservoir. The level should be between the "MAX" and "MIN" lines on the tank.

It is normal for the brake fluid level to go down slightly as the brake pads wear or when the fluid level in the accumulator is high.

If the reservoir needs frequent refilling, it may indicate a serious mechanical problem.

If the level is low, add FMVSS No.116 DOT 3 or SAE J1703 brake fluid to the brake reservoir.

Refilling brake fluid:

1. Turn the ignition switch off.
2. Depress the brake pedal more than 40 times.
3. Remove the reservoir cap by hand. Add brake fluid up to the "MAX" line.

If you do not follow the procedure above, the reservoir may overflow.

Use only newly opened brake fluid. Once opened, brake fluid absorbs moisture from the air, and excess moisture can cause a dangerous loss of braking efficiency.

CAUTION

Take care when filling the reservoir because brake fluid can harm your hands or eyes and damage painted surfaces. If fluid gets in your eyes, flush your eyes with clean water immediately. If you still feel uncomfortable with your eyes, go to the doctor.

NOTICE

If you spill some of the fluid, be sure to wipe it off to prevent it from damaging the parts or paintwork.

CHECKING POWER STEERING FLUID (GS430)



Check the fluid level through the reservoir. If necessary, add automatic transmission fluid DEXRON® II or III.

If the vehicle has been driven around 80 km/h (50 mph) for 20 minutes (a little more in frigid temperatures), the fluid is hot (60°C – 80°C or 140°F – 175°F). You may also check the level when the fluid is cold (about room temperature, 10°C – 30°C or 50°F – 85°F) if the engine has not been run for about five hours.



► **1** If hot O.K. **2** If hot add **3** If cold O.K.
4 If cold add

Clean all dirt off the reservoir and look at the fluid level. If the fluid is cold, the level should be in the "COLD" range. Similarly, if it is hot, the fluid level should be in the "HOT" range. If the level is at the low side of the appropriate range, add automatic transmission fluid DEXRON® II or III to bring the level within the range.

To remove the reservoir cap, turn it counterclockwise and lift up. To reinstall it, turn it clockwise. After replacing the reservoir cap, visually check the steering box case, vane pump and hose connections for leaks or damage.

CAUTION

The reservoir may be hot so be careful not to burn yourself.

CHASSIS

NOTICE

Avoid overfilling, or the power steering could be damaged.

CHECKING POWER STEERING FLUID (GS300)



Check the fluid level on the dipstick. If necessary, add automatic transmission fluid DEXRON® II or III.

If the vehicle has been driven around 80 km/h (50 mph) for 20 minutes (a little more in frigid temperatures), the fluid is hot (60°C – 80°C or 140°F – 175°F). You may also check the level when the fluid is cold (about room temperature, 10°C – 30°C or 50°F – 85°F) if the engine has not been run for about five hours.



► **1** If cold O.K. **2** If hot O.K. **3** Add fluid

1. Clean all dirt off the reservoir.
2. Remove the reservoir cap by turning it counterclockwise and wipe the dipstick clean.
3. Reinstall the reservoir cap.
4. Remove the reservoir cap again and look at the fluid level. If the fluid is cold, the level should be in the "COLD" range on the dipstick. Similarly, if it is hot, the fluid level should be in the "HOT" range. If the level is at the low side of either range, add automatic transmission fluid DEXRON® II or III to bring the level within the range.
5. After replacing the reservoir cap, visually check the steering box case, vane pump and hose connections for leaks or damage.

! CAUTION

The reservoir may be hot so be careful not to burn yourself.

NOTICE

Avoid overfilling, or the power steering could be damaged.

CHASSIS

CHECKING TIRE PRESSURE



The recommended cold tire pressure, tire size and the vehicle capacity weight are given on the label.

You should check the tire pressure every two weeks, or at least once a month. And don't forget the spare! The pressure for the spare tire should be the same with that for the standard tire. (See page 272 or 276.)

Incorrect tire pressure may waste fuel, reduce the comfort of driving, reduce tire life and make your vehicle less safe to drive.

If a tire needs frequent refilling, have it checked by your Lexus dealer.

CAUTION

Keep your tire pressure properly inflated. Otherwise, the following conditions may occur and cause an accident resulting in death or serious injuries.

Low tire pressure (underinflation):

- Excessive wear
- Uneven wear
- Poor handling
- Possibility of blowouts from overheated tire.
- Poor sealing of the tire bead
- Wheel deformation and/or tire separation

High tire pressure (overinflation):

- Poor handling
- Excessive wear at the center of the tire tread
- A greater possibility of tire damage from road hazards

The following instructions for checking tire pressure should be observed:

- **The pressure should be checked only when the tires are cold.** If your vehicle has been parked for at least 3 hours and has not been driven for more than 1.5 km or 1 mile since, you will get an accurate cold tire pressure reading.
- **Always use a tire pressure gauge.** The appearance of the tire can be misleading. Besides, tire pressures that are even just a few pounds off can degrade ride and handling.
- **Do not bleed or reduce tire pressure after driving.** It is normal for the tire pressure to be higher after driving.
- **Never exceed the vehicle capacity weight.** The passengers and luggage weight should be located so that the vehicle is balanced.
- **Be sure to reinstall the tire valve caps.** Without the valve caps, dirt or moisture could get into the valve core and cause air leakage. If the caps have been lost, have new ones put on as soon as possible.

ROTATING TIRES

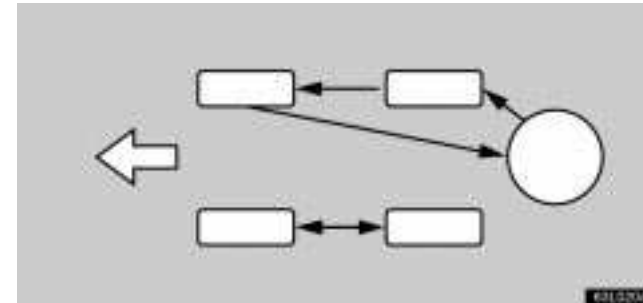

To equalize tire wear and help extend tire life, Lexus recommends that you rotate your tires according to the maintenance schedule. (For scheduled maintenance information, please refer to the “Owner’s Manual Supplement” or “Scheduled Maintenance”.) However, the most appropriate timing for tire rotation may vary according to your driving habits and road surface conditions.

The wheel assemblies must be rotated as illustrated above.

When rotating tires, check for uneven wear and damage. Abnormal wear is usually caused by incorrect tire pressure, improper wheel alignment, out-of-balance wheels, or severe braking.

Before storing radial, snow or studded tires, mark the direction of rotation and be sure to install them in the same direction when using them again. Tires should be stored in a cool dry place.

CHASSIS

CHECKING AND REPLACING TIRES

When to replace your tires



- **1** New tread **2** Tread wear indicator
3 Worn tread

Replace the tires when the tread wear indicators show. The location of the tread wear indicators is shown by the "TWI" or "△" marks molded on the sidewall of each tire.

The tires on your Lexus have built-in tread wear indicators to help you know when the tires need replacement. When the tread depth wears to 1.6 mm (0.06 in.) or less, the indicators will appear. If you can see the indicators in two or more adjacent grooves, the tire should be replaced.

Vehicles equipped with 235/45ZR17 tires: Your Lexus has been fitted with specially developed tires which provide exceptional dynamic performance under general road conditions. However your riding comfort may worsen a little and road noise may increase during driving. You may also notice that your tires will wear more rapidly and tire grip performance will be reduced on the snowy and/or icy roads when compared to standard tires. Be sure to have snow tires or tire chains on the snowy and/or icy roads and drive carefully with the speed appropriate for road conditions.

NOTICE

Low profile tire like 235/45ZR17 may have greater damage than usual tires to its tire wheel when receiving impact from the road surface. Therefore, pay attention to the following.

- *Be sure to use with proper tire pressure. If the tire pressure is low, the tire may have greater damage. For detailed information about tire pressure, see page 272.*
- *Avoid driving onto high, sharp-edged objects and other road hazards. Failure to do so can lead to severe tire damage.*

The effectiveness of snow tires is lost if the tread wears down below 4 mm (0.16 in.).

If you have tire damage such as cuts, splits, cracks deep enough to expose the fabric, or bulges indicating internal damage, the tire should be replaced.

If a tire often goes flat or cannot be properly repaired due to the size or location of a cut or other damage, it should be replaced. If you are not sure, consult with your Lexus dealer.

If an air loss occurs while driving, do not continue driving with a deflated tire. Driving even a short distance can damage a tire beyond repair.

Any tires which are over 6 years old must be checked by a qualified technician even if damage is not obvious.

Tires deteriorate with age even if they have never or seldom been used.

This also applies to the spare tire and tires stored for future use.

Uniform tire quality grading

This information has been prepared in accordance with regulations issued by the National Highway Traffic Safety Administration of the U.S. Department of Transportation. It provides the purchasers and/or prospective purchasers of Lexus vehicles with information on uniform tire quality grading.

Your Lexus dealer will help answer any questions you may have as you read this information.

DOT quality grades – All passenger vehicle tires must conform to Federal Safety Requirements in addition to these grades. Quality grades can be found where applicable on the tire sidewall between tread shoulder and maximum section width. For example: Treadwear 200 Traction AA Temperature A

Treadwear – The treadwear grade is a comparative rating based on the wear rate of the tire when tested under controlled conditions on a specified government test course. For example, a tire graded 150 would wear one and a half (1 – 1/2) times as well on the government course as a tire graded 100. The relative performance of tires depends upon the actual conditions of their use, however, and may depart significantly from the norm due to variations in driving habits, service practices and differences in road characteristics and climate.

CHASSIS

Traction AA, A, B, C – The traction grades, from highest to lowest, are AA, A, B and C, and they represent the tire's ability to stop on wet pavement as measured under controlled conditions on specified government test surfaces of asphalt and concrete. A tire marked C may have poor traction performance.

Warning: The traction grade assigned to this tire is based on braking (straight ahead) traction tests and does not include cornering (turning) traction.

Temperature A, B, C – The temperature grades are A (the highest), B, and C, representing the tire's resistance to the generation of heat and its ability to dissipate heat when tested under controlled conditions on a specified indoor laboratory test wheel. Sustained high temperature can cause the material of the tire to degenerate and reduce tire life, and excessive temperature can lead to sudden tire failure. The grade C corresponds to a level of performance which all passenger car tires must meet under the Federal Motor Vehicle Safety Standard No. 109. Grades B and A represent higher levels of performance on the laboratory test wheel than the minimum required by law.

Warning: The temperature grades for this tire are established for a tire that is properly inflated and not overloaded. Excessive speed, underinflation, or excessive loading, either separately or in combination, can cause heat buildup and possible tire failure.

Tire selection

When replacing a tire, use a tire of the same size and construction, and the same or greater load capacity as the originally installed tires.

Using any other size or type of tire may seriously affect handling, ride, speedometer/odometer calibration, ground clearance, and clearance between the body and tires or snow chains.

CAUTION

Observe the following instructions. Otherwise, an accident may occur resulting in death or serious injuries.

- **Do not mix radial, bias belted, or bias-ply tires on your vehicle, as this may cause dangerous handling characteristics resulting in loss of control.**
- **Do not use tires other than the manufacturer's recommended size, as this may cause dangerous handling characteristics resulting in loss of control.**

INSTALLING SNOW TIRES AND CHAINS

When to use snow tires or chains

Snow tires or chains are recommended when driving on snow or ice.

On wet or dry roads, conventional or radial tires provide better traction than snow or studded tires.

Snow tire selection

If you need snow tires, select tires of the same size, construction and load capacity as the originally installed tires.

Do not use tires other than stated above. Since your vehicle has radial tires as original equipment, make sure your snow tires also have radial construction. Do not install studded tires without first checking local regulations for possible restrictions.

CAUTION

Observe the following instruction. Otherwise, an accident may occur resulting in death or serious injuries.

- **Do not use snow tires other than the manufacturer's recommended size, as this may cause dangerous handling characteristics resulting in loss of control.**

Snow tire installation

Snow tires should be installed on all wheels.

Installing snow tires on the rear wheels only can lead to an excessive difference in road grip capability between the front and rear tires which could cause loss of vehicle control.

CAUTION

- **Do not drive with the snow tires incorrectly inflated.**
- **Never drive over 120 km/h (75 mph) with any type of snow tires.**

Tire chain selection

Regulations regarding the use of tire chains vary according to location or type of road. Always check the local regulations before installing chains.

Use SAE Class "S" type radial tire chains, with the exception of radial cable chains or V-bar type chains.

CHASSIS

Chain installation

Install the chains on the rear tires as tightly as possible. Do not use tire chains on the front tires. Retighten chains after driving 0.5 – 1.0 km (1/4 – 1/2 mile).

When installing chains on your tires, carefully follow the instructions of the chain manufacturer.



CAUTION

- Do not exceed 50 km/h (30 mph) or the chain manufacturer's recommended speed limit, whichever is lower.
- Drive carefully avoiding bumps, holes, and sharp turns, which may cause the vehicle to bounce.
- Avoid sharp turns or locked-wheel braking, as use of chains may adversely affect vehicle handling.
- When driving with chains installed, be sure to drive carefully. Slow down before entering curves to avoid losing control of the vehicle. Otherwise an accident may occur.

REPLACING WHEELS

When to replace your wheels

If you have wheel damage such as bends, cracks or heavy corrosion, the wheel should be replaced.

If you fail to replace a damaged wheel, the tire may slip off the wheel or cause loss of handling control.

Wheel selection

When replacing wheels, care should be taken to ensure that they are equivalent to those removed in load capacity, diameter, rim width, and offset.

Correct replacement wheels are available at your Lexus dealer.

A wheel of a different size or type may adversely affect handling, wheel and bearing life, brake cooling, speedometer/odometer calibration, stopping ability, headlight aim, bumper height, vehicle ground clearance, and tire or snow chain clearance to the body and chassis.

Replacement with used wheels is not recommended as they may have been subjected to rough treatment or high mileage and could fail without warning. Also, bent wheels which have been straightened may have hidden structural damage and therefore should not be used. Never use an inner tube in a leaking wheel which is designed for a tubeless tire.

 **CAUTION**

Observe the following instruction. Otherwise, an accident may occur resulting in death or serious injuries.

- Do not use wheels other than the manufacturer's recommended size, as this may cause dangerous handling characteristics resulting in loss of control.

ALUMINUM WHEEL PRECAUTIONS

- When installing aluminum wheels, check that the wheel nuts are tight after driving your vehicle the first 1600 km (1000 miles).
- If you have rotated, repaired, or changed your tires, check that the wheel nuts are still tight after driving 1600 km (1000 miles).
- When using tire chains, be careful not to damage the aluminum wheels.
- Use only the Lexus wheel nuts and wrench designed for your aluminum wheels.
- When balancing your wheels, use only Lexus balance weights or equivalent and a plastic or rubber hammer.
- As with any wheel, periodically check your aluminum wheels for damage. If damaged, replace immediately.

CHASSIS

SUSPENSION AND CHASSIS



CAUTION

Do not modify the suspension/chassis with lift kits, spacers, springs, etc. It can cause dangerous handling characteristics, resulting in loss of control.

SECTION 6-4

SERVICE PROCEDURES AND SPECIFICATIONS

Electrical components

Specifications	292
Checking battery condition	296
Battery recharging precautions	298
Checking and replacing the blade type fuses	299
Checking the cartridge type fuses	301
Adding washer fluid	303
Checking the headlight aim	303
Replacing light bulbs	309

ELECTRICAL COMPONENTS

SPECIFICATIONS

– FUSE LOCATION



- ▶ **1** *Engine compartment*
- ▶ **2** *Passenger's side kick panel*
- ▶ **3** *Driver's side kick panel*
- ▶ **4** *Engine compartment*

– FUSES

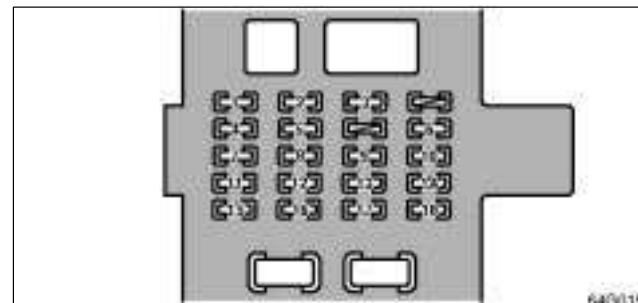

▶ *Driver's side kick panel*

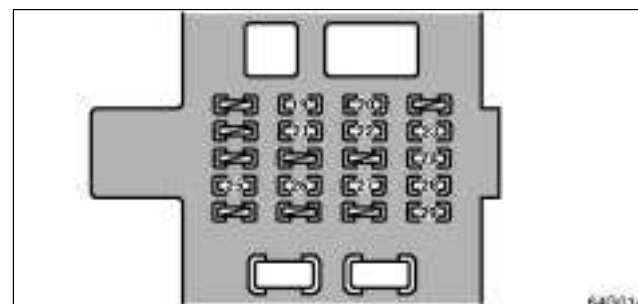

▶ *Passenger's side kick panel*

ELECTRICAL COMPONENTS

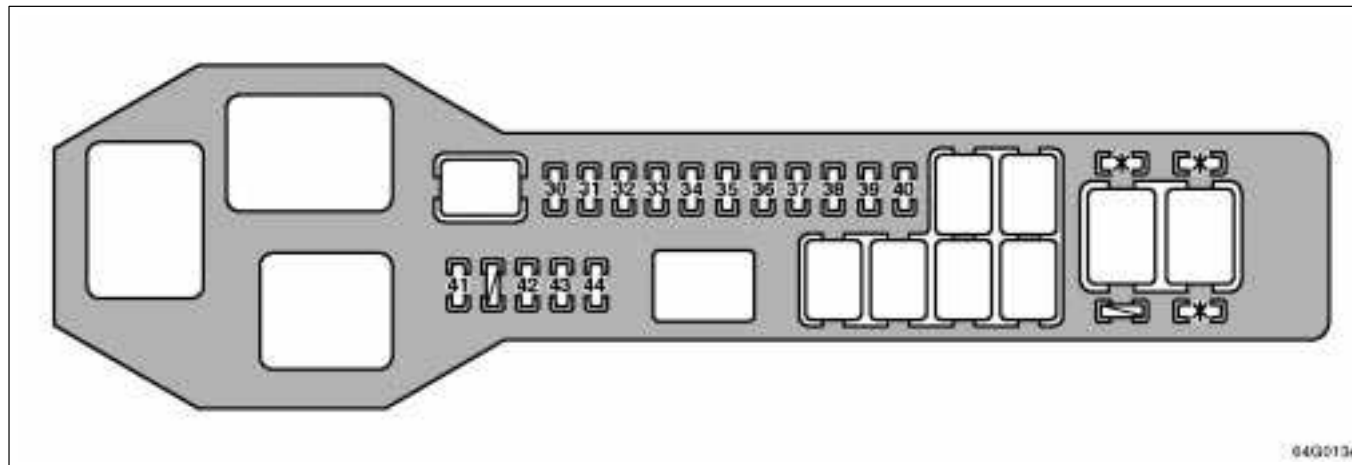

► *Engine compartment*

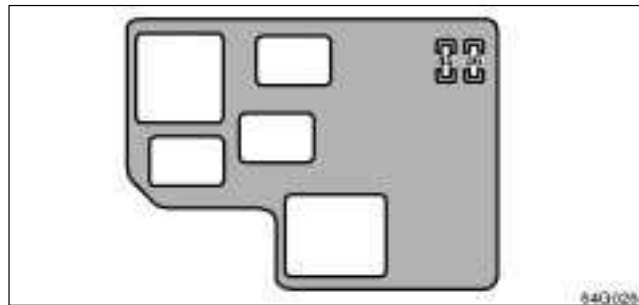

► *Engine compartment*

ELECTRICAL COMPONENTS

No.	FUSE	AMPERE	CIRCUIT
1	WASHER	20	Windshield washer
2	FR FOG	15	Fog lights
3	TAIL	10	Tail lights, Side marker lights, License plate lights, Parking lights
4	GAUGE	10	Back-up lights, Gauges and meters, service reminder indicators and buzzers
5	FUEL OPN	10	Fuel filler door opener
6	PANEL	7.5	Emergency flashers, Headlight cleaner
7	HEATER	10	Air conditioning
8	SRS-B	5	Gauges and meters, service reminder indicators and warning buzzers
9	D P/SEAT	30	Power seat system
10	RADIO NO.2	15	Audio, Shift lock system
11	WIPER	25	Windshield wipers
12	OBD	7.5	On-board diagnosis
13	STOP	15	Stop lights, Anti-lock brake system, Traction control system

No.	FUSE	AMPERE	CIRCUIT
14	CIG	15	Cigarette lighter, Power outlet
15	ECU-IG	15	Power window, Door lock system, Wireless remote control, Theft deterrent system
16	STARTER	5	Starting system
17	IGN	5	Multiport fuel injection system/sequential multiport fuel injection system, SRS, Anti-lock brake system, Vehicle stability control system, Cruise control system
18	D RR DOOR	20	Power window system, Door lock system, Wireless remote control
19	RR FOG	10	No circuit
20	MIR HTR	10	Outside rear view mirror
21	S/ROOF	25	Moon roof
22	ECU-B3	20	Power window system, Door lock system, Wireless remote control
23	P P/SEAT	30	Power seat system, Tilt and telescopic steering
24	DOME	10	Interior lights, Personal lights, Vanity lights, Trunk light, Clock
25	SEAT HTR	20	Seat heater

ELECTRICAL COMPONENTS

No.	FUSE	AMPERE	CIRCUIT
26	4WS	25	No circuit
27	TV	15	No circuit
28	ECU-B2	10	Power seat system
29	P RR DOOR	20	Power window system, Door lock system, Wireless remote control
30	ECU-B1	20	Power window system, Door lock system, Wireless remote control, Theft deterrent system, Trunk lid opener, Interior lights, Personal lights, Clock, Headlight cleaner
31	P FR DOOR	20	Power window system, Door lock system, Wireless remote control
32	D FR DOOR	20	Power window system, Door lock system, Wireless remote control
33	HORN	10	Horn
34	ETCS	15	Electronic throttle control system
35	AM2	15	Starting system, Multiport fuel injection system/sequential multiport fuel injection system
36	TEL	15	No circuit
37	TURN-HAZ	10	Turn signal lights

No.	FUSE	AMPERE	CIRCUIT
38	EFI	25	Multiport fuel injection system/sequential multiport fuel injection system, Emission control system
39	ALT-S	5	Charging system
40	RADIO NO.1	30	Audio
41	DRL NO.2	30	Daytime running light system
42	DRL NO.1	30	Daytime running light system
43	H-LP L LWR	15	Left-hand headlight (low beam)
44	H-LP R LWR	15	Right-hand headlight (low beam)
45	H-LP R UPR	15	Right-hand headlight (high beam)
46	H-LP L UPR	15	Left-hand headlight (high beam)
*	SPARE		Spare fuse

ELECTRICAL COMPONENTS

CHECKING BATTERY CONDITION

Precautions

 **CAUTION**

BATTERY PRECAUTIONS

The battery produces flammable and explosive hydrogen gas.

- Do not cause a spark by contacting the battery terminals with tools.
- Do not smoke or light a match near the battery.

The electrolyte contains poisonous and corrosive sulfuric acid.

- Avoid contact with eyes, skin or clothes.
- Never inhale or swallow electrolyte.
- Wear protective safety glasses when working near the battery.
- Keep children away from the battery.

EMERGENCY MEASURES

- If electrolyte gets in your eyes, flush your eyes with clean water for at least 15 minutes and get immediate medical attention. If possible, continue to apply water with a sponge or cloth while traveling to the medical office.

- If electrolyte gets on your skin, thoroughly wash the contacted area. If you feel a pain or burn, get medical attention immediately.
- If electrolyte gets on your clothes, there is a possibility of its soaking through to your skin, so immediately take off the exposed clothing and follow the procedure above, if necessary.
- If you accidentally swallow electrolyte, drink a large quantity of water or milk. Follow with milk of magnesia, beaten raw egg or vegetable oil. Then go immediately for emergency help.
- **Warning:** Battery posts, terminals and related accessories contain lead and lead compounds, chemicals known to the State of California to cause cancer and reproductive harm. Wash hands after handling.

Checking battery exterior

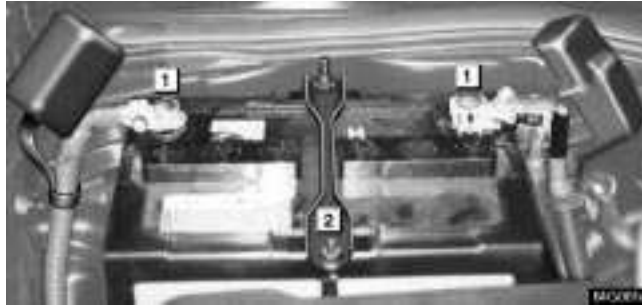

► **1** Terminals **2** Hold-down clamp

Check the battery for corroded or loose connections, cracks, or loose hold-down clamps.

1. If the battery is corroded, wash it off with a solution of warm water and baking soda. Coat the terminals with grease to prevent further corrosion.
2. If the connections are loose, tighten the clamp bolts – but do not overtighten.
3. Tighten the hold-down clamp only enough to keep the battery firmly in place. Overtightening may damage the battery case.

NOTICE

- *Make sure the engine and all accessories are turned off before performing maintenance.*
- *When checking the battery, remove the ground cable first and reinstall it last.*
- *Be careful not to cause a short circuit with tools.*
- *Take care no solution gets into the battery when washing it.*

ELECTRICAL COMPONENTS

Checking battery condition

Checking by indicator

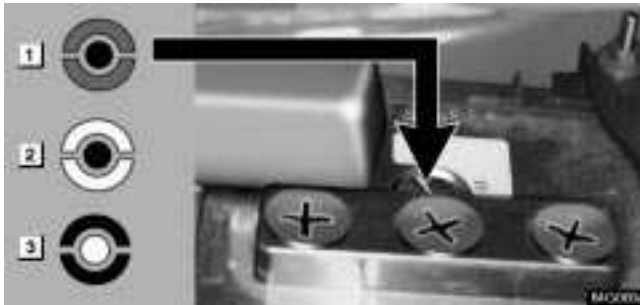

Check the battery condition by the indicator color.

- 1 BLUE – Good condition.
- 2 WHITE – Charging necessary. Have the battery checked by your Lexus dealer.
- 3 RED – Have the battery checked by your Lexus dealer.

NOTICE

Do not refill the battery with water.

BATTERY RECHARGING PRECAUTIONS

During recharging, the battery is producing hydrogen gas.

Therefore, before recharging:

1. If recharging with the battery installed on the vehicle, be sure to disconnect the ground cable.
2. Make sure the power switch on the recharger is off when connecting the charger cables to the battery and when disconnecting them.

CAUTION

- Always charge the battery in an unconfined area. Do not charge the battery in a garage or closed room where there is not sufficient ventilation.
- Only do a slow charge (5 A or less). Charging at a quicker rate is dangerous. The battery may explode causing personal injuries.

NOTICE

Never recharge the battery while the engine is running. Also, be sure all accessories are turned off.

CHECKING AND REPLACING THE BLADE TYPE FUSES



► *Driver's side kick panel*



► *Passenger's side kick panel*



► *Engine compartment* 1 Spare fuses 2 Pull-out tool



► *Engine compartment*

1. Turn the ignition switch off and open the fuse box lid.

Determine which fuse may be causing the problem. The lid of the fuse box shows the name of the circuit for each fuse.

ELECTRICAL COMPONENTS

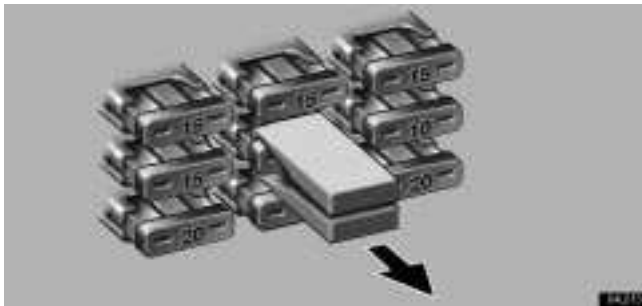

2. Make sure the inoperative component is turned off. Pull the suspected fuse straight out with the pull-out tool and check it. If it has blown, push a new fuse into the clips.



► **Good**

► **Blown**

a. Look carefully at the fuse. If the thin wire is broken, the fuse has blown. If you are not sure or if it is too dark to see, try replacing the suspected fuse with one of the same value that you know is good.

b. Install only a fuse with the amperage rating designated on the fuse box lid.

If you do not have a spare fuse, in an emergency you can pull out the "CIG", "RAD NO.1" or "OBD" fuse, which may be dispensable for normal driving, and use it if its amperage rating is the same.

If you cannot use one of the same amperage, use one lower than, but as close as possible to, the amperage. If the amperage is lower than that specified, the fuse might blow out again but this does not indicate anything wrong. Be sure to get the correct fuse as soon as possible and return the substitute to its original clips.

It is a good idea to purchase a set of spare fuses and keep them in your vehicle for emergencies.

If the new fuse immediately blows out, there is a problem with the electrical system. Have your Lexus dealer correct it as soon as possible.

 **CAUTION**

Never use a fuse with a higher amperage rating, or any other object, in place of a fuse. This may cause extensive damage and possibly a fire.

CHECKING THE CARTRIDGE TYPE FUSES

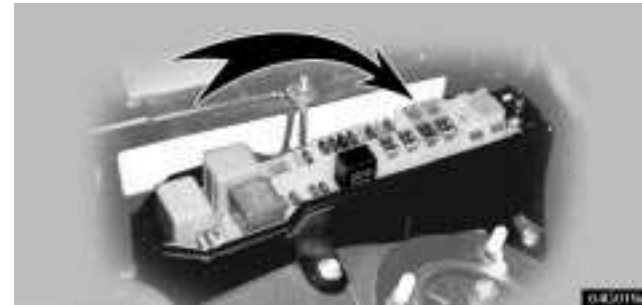

► *Engine compartment*

ELECTRICAL COMPONENTS

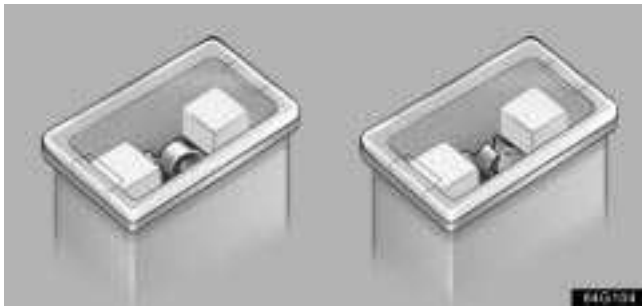

► **Good**

► **Blown**

If the headlights or other electrical components do not work and the blade type fuses are O.K., check the cartridge type fuses. If any of the cartridge type fuses are blown, they must be replaced.

If there is an overload in the circuits from the battery, the fuses are designed to blow before the entire wiring harness is damaged.



CAUTION

Always use a genuine Lexus fuse or equivalent for replacement. Never install an ordinary wire – even for a temporary fix. This may cause extensive damage and possibly a fire.

NOTICE

Before replacing the fuses, have the cause of electrical overload determined and repaired by your Lexus dealer.

ADDING WASHER FLUID



If the washer tank becomes nearly empty, add washer fluid.

You may use plain water as washer fluid. However, in cold areas where temperatures range below the freezing point, use washer fluid containing antifreeze. This product is available at your Lexus dealer and most auto parts stores. Follow the manufacturer's directions for how much to mix with water.

NOTICE

Do not use engine antifreeze or any other substitute because it may damage your vehicle's paint.

CHECKING THE HEADLIGHT AIM



- ▶ **1** *Beam angle gauge*
(vertical movement for low beam)
- 2** *Beam angle gauge*
(horizontal movement for low beam)
- 3** *Beam angle gauge*
(vertical movement for high beam)
- 4** *Beam angle gauge*
(horizontal movement for high beam)

Before checking the headlight aim:

1. Be sure that the body around the headlight is not deformed.
2. Park the vehicle on a level spot.
3. The driver gets into the driver's seat and puts the vehicle in a state readying for a driving (with a full tank).
4. Bounce the vehicle several times.

ELECTRICAL COMPONENTS

Adjusting the headlight aiming (low beam)



- ▶ **1** *Adjusting bolt A*
- ▶ **2** *Adjusting bolt B*



- ▶ **1** *Bubble* **2** *Acceptable range*

Vertical movement gauge: The bubble of the gauge should not deviate from the center of the gauge by more than 2 marks to either side of the gauge.

If the bubble is out of the acceptable range of the beam angle gauge, adjust it using bolt A and B.

ELECTRICAL COMPONENTS



1. Turn the bolt A in either direction using a Phillips-head screwdriver. At this time, keep the turning direction and number of turns in mind.



2. Turn the bolt B the same number of turns and in the same direction as step 1 using a Phillips-head screwdriver.

ELECTRICAL COMPONENTS

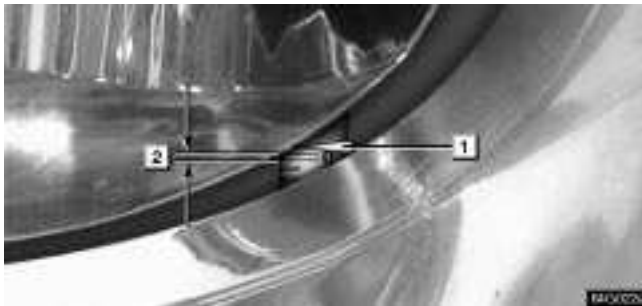

- **1** *Mark* **2** *Acceptable range*

Horizontal movement gauge: The mark should not deviate by more than one mark to either side of the gauge.

If the edge of the lens is out of the acceptable range of the beam angle gauge, adjust it using bolt B.

If the error is over the value specified above, take the vehicle to your Lexus dealer to adjust the headlight aim.

After adjusting the headlight in the vertical direction, check that the light has been shifted from the adjusted position in the horizontal direction.

Adjusting the headlight aiming (high beam)



- **1** *Adjusting bolt A*
2 *Adjusting bolt B*

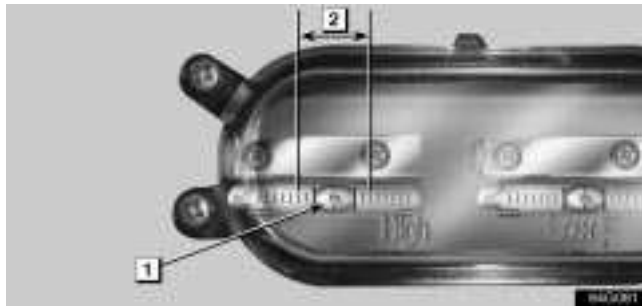

► **1** *Bubble* **2** *Acceptable range*

Vertical movement gauge: The bubble of the gauge should not deviate from the center of the gauge by more than 2 marks to either side of the gauge.

If the bubble is out of the acceptable range of the beam angle gauge, adjust it using bolt A.



Turn the bolt A in either direction using a Phillips-head screwdriver.

ELECTRICAL COMPONENTS



► **1** Red line **2** Acceptable range

Horizontal movement gauge: The red line should not deviate by more than 2 blue lines to either side of the gauge.

If the red line is out of the acceptable range of the beam angle gauge, adjust it using bolt B.



Turn the bolt B in either direction using a Phillips-head screwdriver.

If the error is over the value specified above, take the vehicle to your Lexus dealer to adjust the headlight aim.

REPLACING LIGHT BULBS

The illustrations on the following pages show the locations of light bulbs. If it is necessary to replace a bulb, take your vehicle to your Lexus dealer as soon as possible. Use bulbs with the bulb numbers and wattage ratings given in the table.

 **CAUTION**

- To prevent burning yourself, do not replace the light bulbs while they are hot.
- Halogen bulbs have pressurized gas inside and require special handling. They can burst or shatter if scratched or dropped. Hold a bulb only by its plastic or metal case. Do not touch the glass part of a bulb with bare hands.

Vehicles with discharge headlights:

- Do not touch the high voltage socket when the headlights turn on. 20000 V is momentarily generated and may cause severe injury by electric shock.
- Do not disassemble, repair or take apart the headlight bulbs, connector, power supply circuits and rotated components. Or you may be injured by electric shock. Call your dealer when the headlights fail to work or have to be replaced or disposed of.

NOTICE

Only use a bulb of the listed type.

The inside of the lens of exterior lights such as headlights may temporarily fog up when the lens becomes wet in the rain or in a car wash. This is not a problem because the fogging is caused by the temperature difference between the outside and inside of the lens, just like the windshield fogged up in the rain. However, if there is a large drop of water on the inside of the lens, or if there is water pooled inside the light, contact your Lexus dealer.

ELECTRICAL COMPONENTS

LIGHT LOCATION

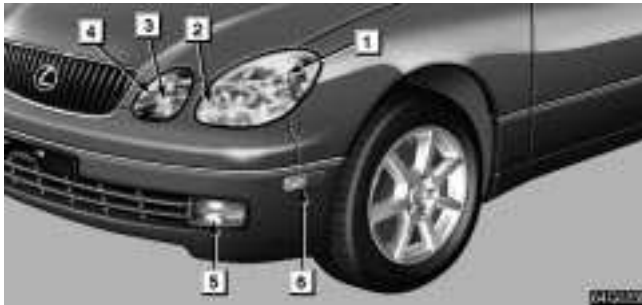

Light Bulbs	Bulb No.	W	Type
1 Headlight (Low beam) Discharge bulb	D2R	35	B
Halogen bulb	HB4	51	C
2 Front turn signal light	—	21	D
3 Headlight (High beam)	HB3	60	A
4 Parking light	—	5	D
5 Fog light	HB4	51	C
6 Front side marker light	194	3.8	D



Light Bulbs	Bulb No.	W	Type
1 Trunk light	194	3.8	D
2 High mounted stoplight	—	5	D
3 Tail/stop light	—	5/21	D
4 Tail light	—	5/21	D
5 Rear turn signal light	—	21	D
6 Back-up light	921	16	D
7 Tail/stop light	—	5/21	D
8 License plate light	—	5	D

ELECTRICAL COMPONENTS

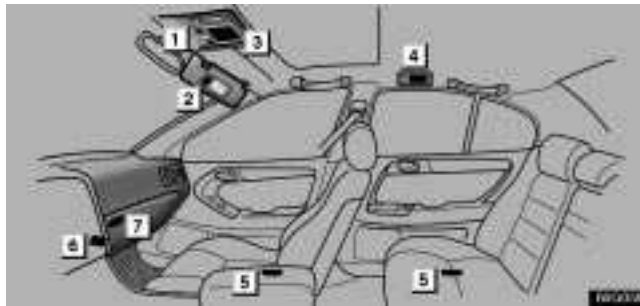

Light Bulbs	Bulb No.	W	Type
1 Front personal lights	—	8	F
2 Vanity lights	—	3	E
3 Front interior lights	—	8	E
4 Rear personal lights	—	5	F
5 Door courtesy lights	194	3.8	D
6 Foot lights	—	1.4	D
7 Glove box light	—	1.2	D

- A: HB3 halogen bulbs
- B: D2R discharge bulbs
- C: HB4 halogen bulbs
- D: Wedge base bulbs
- E: Double end bulbs
- F: Single end bulbs

SECTION 6-5

SERVICE PROCEDURES AND SPECIFICATIONS

Body

Specifications	314
Protecting your vehicle from corrosion	315
Washing and waxing	316
Cleaning the interior	318

BODY

SPECIFICATIONS

– DIMENSIONS AND WEIGHT

Overall length	4805 mm (189.2 in.)
Overall width	1800 mm (70.9 in.)
Overall height	1440 mm (56.7 in.)*
Wheelbase	2800 mm (110.2 in.)
Tread – Front	1535 mm (60.4 in.)
– Rear	1510 mm (59.4 in.)
Vehicle capacity weight (occupants + luggage)	400 kg (880 lb.)

*Unladen vehicle

– FUEL TANK

Capacity	75 L (19.8 gal., 16.5 Imp.gal.)
----------	---------------------------------

PROTECTING YOUR VEHICLE FROM CORROSION

Proper care of your Lexus can help ensure long-term corrosion prevention.

The most common causes of corrosion to your vehicle are:

- The accumulation of road salt, dirt and moisture in hard-to-reach areas under the vehicle.
- Chipping of paint or undercoating caused by minor accidents or by stones and gravel.

The following conditions will cause or accelerate corrosion of your vehicle, so it is important to keep your vehicle, particularly the underside, as clean as possible and to repair any damage to paint or protective coatings as soon as possible.

- The presence of road salt or dust control chemicals, salt in the air near the sea coast, industrial air pollution.
- High humidity, especially at temperatures just above freezing point.
- Certain parts of your vehicle are wet or damp for an extended period of time, even though other parts of the vehicle are dry.
- Components of the vehicle which do not dry quickly due to lack of proper ventilation are exposed to high ambient temperature.

To help prevent corrosion on your Lexus, follow these guidelines:

Keep your vehicle clean by regular washing. In addition, observe the following points.

- If you drive on salted roads in the winter or if you live near the ocean, you should hose off the undercarriage at least once a month to minimize corrosion.
- High pressure water or steam is effective for cleaning the vehicle's underside and wheel housings. Pay particular attention to these areas as it is difficult to see all the mud and dirt. It will do more harm than good to simply wet the mud and debris without removing them. The lower edge of doors, rocker panels and frame members have drain holes which should not be allowed to clog with dirt as trapped water in these areas can cause corrosion.
- Wash the underside of the vehicle thoroughly when winter is over.

See "Washing and waxing" on page 316 for more tips.

Check the condition of your vehicle's paint and trim. If you find any chips or scratches in the paint, touch them up immediately to prevent corrosion from starting. If the chips or scratches have gone through the bare metal, have a qualified body shop make the repair.

BODY

Check the interior of your vehicle. Water and dirt can accumulate under the floor mats and could cause corrosion. Occasionally check under the mats to make sure the area is dry. Be particularly careful when transporting chemicals, cleansers, fertilizers, salt, etc. These should be transported in proper containers. If a spill or leak should occur, immediately clean and dry the area.

Keep your vehicle in a well ventilated garage or a roofed place. Do not park your vehicle in a damp, poorly ventilated garage. If you wash your vehicle in the garage, or if you drive it covered with water or snow, your garage may be so damp and it will cause corrosion. Even if your garage is heated, a wet vehicle can corrode if the ventilation is poor.

WASHING AND WAXING

Washing your Lexus

Keep your vehicle clean by regular washing.

The following cases may cause weakness to the paint or corrosion to the body and parts. Wash your vehicle as soon as possible.

- When driving in a coastal area
- When driving on a road sprinkled with antifreeze
- When having coal tar, tree sap, bird droppings and carcass of an insect
- When driving in the areas where there is a lot of smoke, soot, dust, iron dust and chemical substances
- When the vehicle becomes remarkably dirty with dust and mud

Hand-washing your Lexus

Work in the shade and wait until the vehicle body is not hot to the touch.

1. Rinse off loose dirt with a hose. Remove any mud or road salt from the underside of the vehicle or in the wheel wells.
2. Wash with a mild car-wash soap, mixed according to the manufacturer's instructions. Use a soft cotton mitt and keep it wet by dipping it frequently into the wash water. Do not rub hard – let the soap and water remove the dirt.

Plastic wheel ornaments: The plastic wheel ornaments are damaged easily by organic substances. If any organic substance splashes an ornament, be sure to wash it off with water and check if the ornament is damaged.

 **CAUTION**

Do not attach the heavily damaged plastic wheel ornament. It may fly off the wheel and cause accidents while the vehicle is moving.

Aluminum wheels: Use only a mild soap or neutral detergent.

Urethane bumpers and side moldings: Wash carefully. Do not scrub with abrasive cleaners. The bumper and side molding faces are soft.

Road tar: Remove with turpentine or cleaners that are marked safe for painted surfaces.

NOTICE

Do not use organic substances (gasoline, kerosene, benzine or strong solvents), which may be toxic or cause damage.

3. Rinse thoroughly – dried soap can cause streaking. In hot weather you may need to rinse each section right after you wash it.

4. To prevent water spots, dry the vehicle using a clean soft cotton towel. Do not rub or press hard – you might scratch the paint.

Automatic car wash

Your vehicle may be washed in an automatic car wash, but remember that the paint can be scratched by some types of brushes, unfiltered washing water, or the washing process itself. Scratching reduces paint durability and gloss, especially on darker colors. The manager of the car wash should be able to advise you whether the process is safe for the paint on your vehicle.

Waxing your Lexus

Polishing and waxing is recommended to maintain the original beauty of your Lexus' finish.

Apply wax once a month or if the vehicle surface does not repel water well.

1. Always wash and dry the vehicle surface before you begin waxing, even if you are using a combined cleaner and wax.
2. Use a good quality polish and wax. If the finish has become extremely weathered, use a car-cleaning polish, followed by a separate wax. Carefully follow the manufacturer's instructions and precautions. Be sure to polish and wax the chrome trim as well as the paint.
3. Wax the vehicle again when water does not bead but remains on the surface in large patches.

BODY

CLEANING THE INTERIOR



CAUTION

- Be careful not to splash water or spill liquid on the floor. This may prevent the side airbags from activating correctly, resulting in serious injury.
- Do not wash the vehicle floor with water, or allow water to get onto the floor when cleaning the vehicle interior or exterior. Water may get into audio components or other electrical components above or under the floor carpet (or mat) and cause a malfunction; and it may cause body corrosion.

Leather Interior

The selected leather is used in your Lexus. Due to characteristics of leather products, some parts of leather may be rough, uneven or scratched originally.

To keep good appearance, we recommend you to clean it periodically twice a year.

Remove dirt on the leather in the following ways:

1. Wipe it off lightly using a soft cloth (e.g. gauze) dampened with 5% solution of neutral detergent for wool.
2. Wring water from a clean cloth and thoroughly wipe off all traces of detergent with it.

3. Wipe off the surface of the leather with a dry soft cloth. Allow the leather to dry in a ventilated shaded area. Excess of wet may cause the hardening or shrinking of the leather.

NOTICE

- *Dirt or sand adhered to the leather may damage the treated surface and cause it to wear earlier. Remove dirt or sand using a vacuum cleaner.*
- *If a stain should fail to come out with a neutral detergent, apply a cleaner that does not contain an organic solvent.*
- *Never use organic substances such as benzene, alcohol or gasoline, or alkaline or acid solutions for cleaning the leather as these could cause discoloring.*
- *Use of a nylon brush or synthetic fiber cloth, etc. may scratch the fine grained surface of the leather.*
- *Mildew may develop on soiled leather upholstery. Be especially careful to avoid oil spots. Try to keep your upholstery always clean.*
- *Long exposure to direct sunlight may cause the leather surface to harden and shrink. Keep your vehicle in a shaded area, especially in the summer.*
- *The interior of your vehicle is apt to heat up on hot summer days, so avoid placing on the upholstery items made of vinyl or plastic or containing wax as these tend to stick to leather when warm.*

- *Improper cleaning of the leather upholstery could result in discoloration or staining.*

Synthetic Leather Areas (Dash and sun visors)

The synthetic leather areas may be easily cleaned with a mild soap or detergent and water.

First vacuum over the upholstery to remove loose dirt. Then, using a sponge or soft cloth, apply the soap solution to the synthetic leather. After allowing it to soak in for a few minutes to loosen the dirt, remove the dirt and wipe off the soap with a clean damp cloth. If all the dirt does not come off, repeat the procedure. Commercial foaming-type cleaners are also available which work well. Follow the manufacturer's instructions.

NOTICE

Do not use solvent, thinner, gasoline or window cleaner on the interior.

Carpets, Windows and Seat Belts

Begin by vacuuming thoroughly to remove as much dirt as possible. Several types of foam cleaners are available; some are in aerosol cans and others are powders or liquids which you mix with water to produce a foam. To shampoo the carpets, use a sponge or brush to apply the foam. Rub in overlapping circles. Do not apply water – the best results are obtained by keeping the carpet as dry as possible. Read the shampoo instructions and follow them closely.

The seat belts may be cleaned with mild soap and water or with lukewarm water.

Use a cloth or sponge. As you are cleaning, check the belts for excessive wear, fraying or cuts.

NOTICE

- *Use a good foam-type shampoo to clean the carpets.*
- *Do not use dye or bleach on the belts – it may weaken them.*
- *Do not use the belts until they become dry.*
- *The windows may be cleaned with any household window cleaner.*
- *When cleaning the inside of the rear window, be careful not to scratch or damage the heater wires.*

BODY

Air Conditioning Control Panel, Car Audio, Instrument Panel, Console Panel, and Switches

Use a soft damp cloth for cleaning.

Soak a clean soft cloth in water or lukewarm water then lightly wipe off any dirt.

NOTICE

- *Do not use organic substances (solvents, kerosene, alcohol, gasoline, etc.) or alkaline or acidic solutions. These chemicals can cause discoloring, staining or peeling of the surface.*
- *If you use cleaners or polishing agents, make sure their ingredients do not include the substances mentioned above.*
- *If you use a liquid car freshener, do not spill the liquid onto the vehicle's interior surfaces. It may contain the ingredients mentioned above. Immediately clean any spill using the method mentioned above.*

If you have any questions about the cleaning of your Lexus, your local Lexus dealer will be pleased to answer them.

SECTION 7

REPORTING SAFETY DEFECTS FOR U.S. OWNERS

Reporting safety defects for U.S. owners

[Reporting safety defects for U.S. owners](#) 322

REPORTING SAFETY DEFECTS FOR U.S. OWNERS

REPORTING SAFETY DEFECTS FOR U.S. OWNERS

If you believe that your vehicle has a defect which could cause a crash or could cause injury or death, you should immediately inform the National Highway Traffic Safety Administration (NHTSA) in addition to notifying Toyota Motor Sales, U.S.A., Inc. (Toll-free: 1-800-25-LEXUS).

If NHTSA receives similar complaints, it may open an investigation, and if it finds that a safety defect exists in a group of vehicles, it may order a recall and remedy campaign. However, NHTSA cannot become involved in individual problems between you, your dealer, or Toyota Motor Sales, U.S.A., Inc.

To contact NHTSA, you may either call the Auto Safety Hotline toll-free at 1-800-424-9393 (or 366-0123 in Washington, D.C. area) or write to: NHTSA, U.S. Department of Transportation, Washington, D.C. 20590. You can also obtain other information about motor vehicle safety from the Hotline.